

slides

PST Series
Precision Slide Table

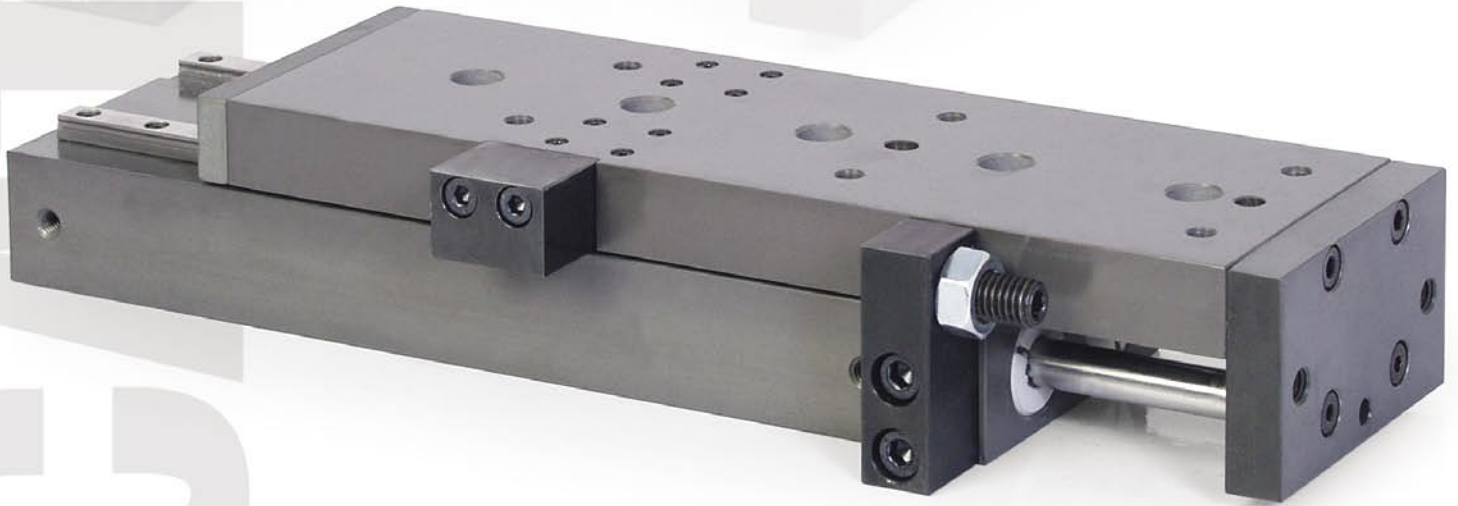

NUMATICS

PST Series Power Slides	3-15
Features and Benefits	3
How To Order	3
PST08 Technical Specifications	4
PST08 Dimensions	5
PST12 Technical Specifications	6
PST12 Dimensions	7
PST16 Technical Specifications	8
PST16 Dimensions	9
PST20 Technical Specifications	10
PST20 Dimensions	11
PST25 Technical Specifications	12
PST25 Dimensions	13
Switch Information	14-15



PST Precision Slide

PST Series Slide provides smooth precise linear motion with high accuracy at twice the thrust of a single bore cylinder. The precision linear rail system supports the load through the entire stroke length.

A.

Dual square rails provide high load capabilities and precise linear motion.

B.

Twin bores deliver twice the thrust of a single bore cylinder.

C.

Optional stroke adjustment and shock absorbers available for extend and retract.

D.

Axial mounting and locating holes standard.

E.

Sensing groove for Hall or Reed switches.

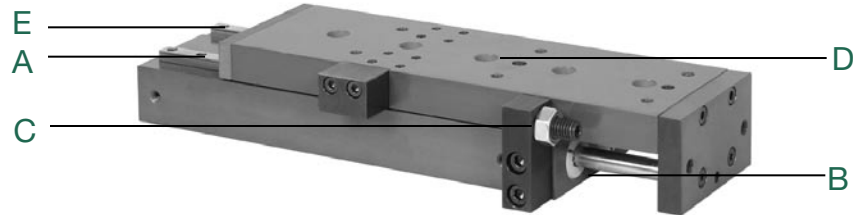

How to Order

PST 16 050 B 1 6 D 4*4*

Bore Sizes

- 08 = 8 mm
- 12 = 12 mm
- 16 = 16 mm
- 20 = 20 mm
- 25 = 25 mm

Standard Stroke

- 010 = 10 mm 050 = 50 mm
- 020 = 20 mm 075 = 75 mm
- 030 = 30 mm 100 = 100 mm*
- 040 = 40 mm

* Not available for 8 mm bore

Seal Option

- 1 = Buna
- 2 = Viton

Sensing Type

Standard Cord Set

- 1 = Hall Switch - PNP (sourcing)
- 2 = Hall Switch - NPN (sinking)
- 3 = Reed Switch
- 6 = No Sensing

Quick Disconnect Cord Set

- Z = Hall Switch - PNP (sourcing)
- Y = Hall Switch - NPN (sinking)
- X = Reed Switch

See Sensor section.

*** When calling out shocks for extend or retract, the shock becomes the stroke adjustment. Therefore, you do not have to order both stroke adjustment and shocks.**

Shock Option

Hardware Only

- 1 = Extend
- 2 = Retract
- 3 = Extend/Retract
- 4 = No Shock Hardware

Hardware and Shocks

- A = Extend
- B = Retract
- C = Extend/Retract

Stroke Adjustment

- 1 = Extend Stroke
- 2 = Retract Stroke
- 3 = Extend/Retract
- 4 = No Stroke Adjustment

Sensing Position

- A = Single Position Extend
- B = Single Position Retract
- C = Extend and Retract
- D = No Sensing

Extend Stroke Adjustment Kit

MODEL NO.	PART NO.
PST08	PSTSAKE08
PST12	PSTSAKE12
PST16	PSTSAKE16
PST20	PSTSAKE20
PST25	PSTSAKE25

Retract Stroke Adjustment Kit

MODEL NO.	PART NO.
PST08	PSTSAKR08
PST12	PSTSAKR12
PST16	PSTSAKR16
PST20	PSTSAKR20
PST25	PSTSAKR25

When Ordering Additional Sensors

SWITCH DESCRIPTION	STANDARD PART NO.	QUICK DISCONNECT PART NO.
Hall Effect - PNP (Sourcing)	HPNPS31	HPNPQ31
Hall Effect - NPN (Sinking)	HNPNS32	HNPNQ32
Reed Switch	RSS02	RSQ02
90° 5 meter cable	-	PXC90
Straight 5 meter cable	-	PXCST



PST Series Precision Slides

NUMATICS®

PST08 Technical Specifications

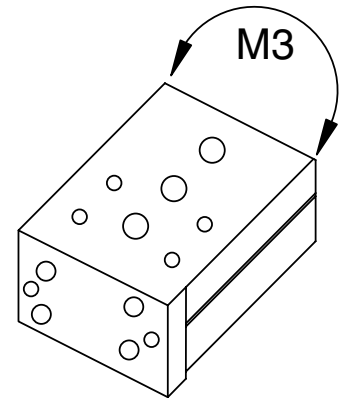
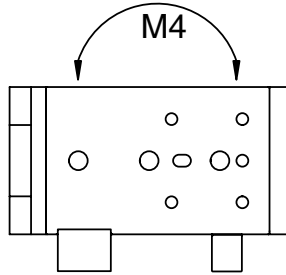
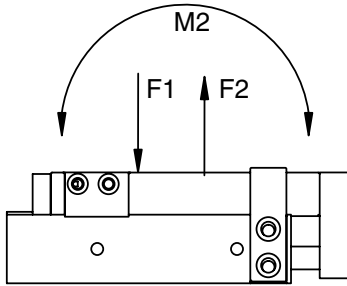

Technical Specifications (Dynamic Ratings)

	PST08
M2 Nm (in.-lbs.)	2.2 (19.4)
M3 Nm (in.-lbs.)	2.6 (22.9)
M4 Nm (in.-lbs.)	2.8 (24.7)
F1: kg (lbs)	7.1 (15.6)
F2: kg (lbs)	4.8 (10.5)

Unit Output Force Table

BORE	EXTEND	RETRACT
08 (piston area inches sq.)	0.156	0.117
08 (piston area mm sq.)	100.5	75.4

Example:

Pounds = Psi x Piston Area inches sq.

Newtons = Mpa x Piston Area mm sq.

PST08 Dimensions

	STROKE MM (INCHES)						
	10	20	30	40	50	75	
A	6.1 (.24)	7.3 (.29)	7.3 (.29)	7.3 (.29)	7.3 (.29)	7.3 (.29)	
F	25 (.98)	25 (.98)	40 (1.58)	50 (1.97)	38 (1.50)	50 (1.97)	
G	9 (.35)	12 (.47)	13 (.51)	15 (.59)	20 (.79)	27 (1.06)	
GA	17 (.67)	12 (.47)	33 (1.30)	43 (1.69)	43 (1.69)	83 (3.27)	
H	28 (1.10)	30 (1.18)	20 (.79)	28 (1.10)	23 (.91)	28 (1.10)	
HA	20 (.79)	30 (1.18)	20 (.79)	28 (1.10)	46 (1.81)	56 (2.20)	
J	27.3 (1.08)	31.2 (1.23)	42.2 (1.66)	60.2 (2.37)	78.2 (3.08)	128.2 (5.05)	
K	20.3 (.80)	30.4 (1.20)	40.4 (1.59)	50.4 (1.98)	60.5 (2.38)	85.4 (3.36)	
M	49 (1.93)	54 (2.13)	65 (2.56)	83 (3.27)	101 (3.98)	151 (5.95)	
N	4	4	4	4	6	6	
NN	2	2	3	3	4	5	
Z	48.5 (1.91)	53.5 (2.11)	64.5 (2.54)	82.5 (3.25)	100.5 (3.96)	150.5 (5.93)	
ZZ	56 (2.20)	61 (2.40)	72 (2.83)	90 (3.54)	108 (4.25)	158 (6.22)	



PST08

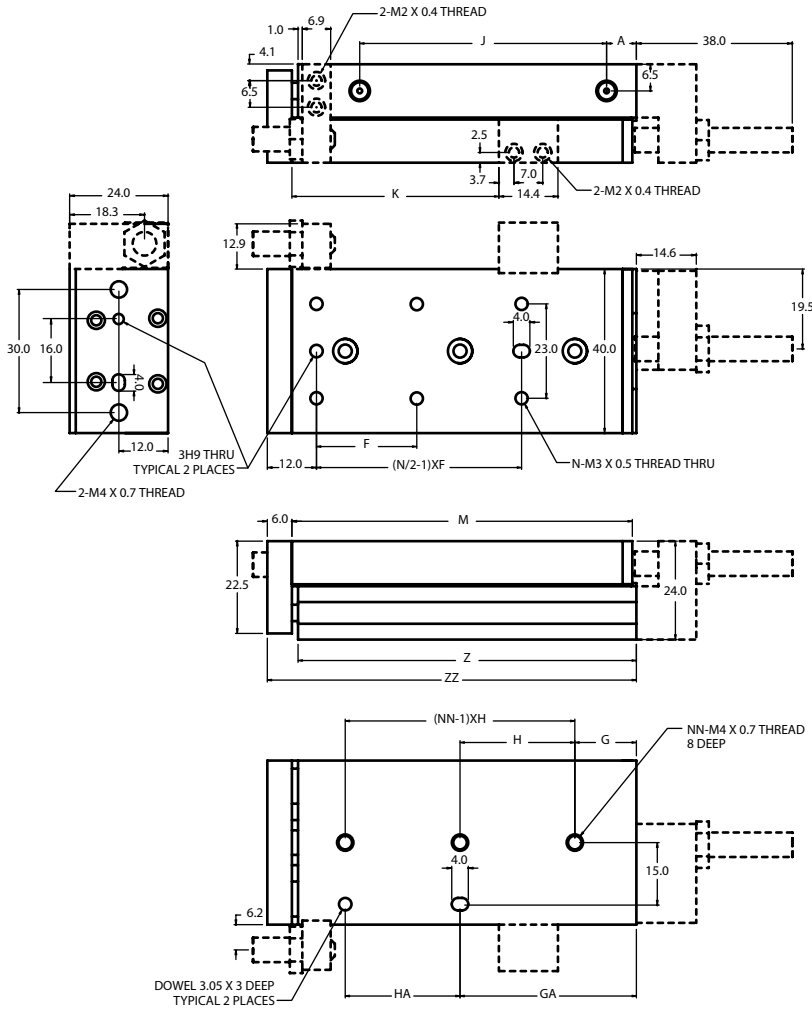

Shown with optional stroke adjustment

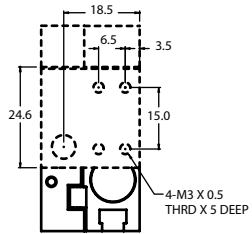

Shown With Optional Shock Absorbers

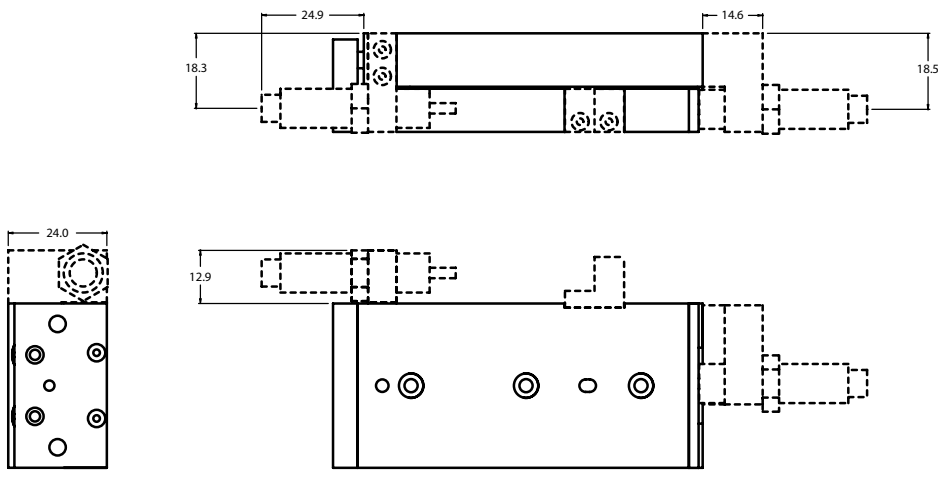



PST Series Precision Slides

NUMATICS®

PST12 Technical Specifications

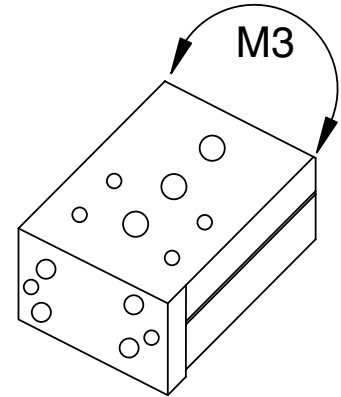
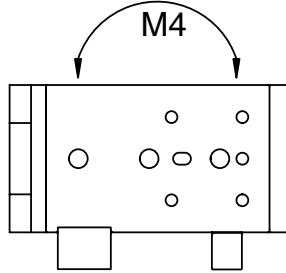
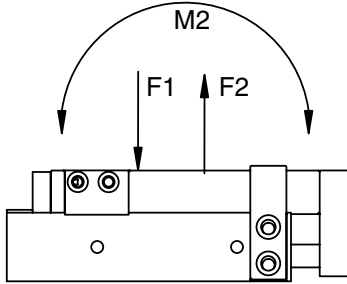

Technical Specifications (Dynamic Ratings)

	PST12
M2 Nm (in.-lbs.)	11.7 (103.8)
M3 Nm (in.-lbs.)	8.9 (78.8)
M4 Nm (in.-lbs.)	14.0 (123.9)
F1: kg (lbs)	12.9 (28.3)
F2: kg (lbs)	9.0 (19.8)

Unit Output Force Table

BORE	EXTEND	RETRACT
12 (piston area inches sq.)	0.351	0.263
12 (piston area mm sq.)	226.2	169.7

Example:

Pounds = Psi x Piston Area inches sq.

Newtons = Mpa x Piston Area mm sq.

PST12 Dimensions

	STROKE MM (INCHES)						
	10	20	30	40	50	75	100
A	9.4 (.37)	9.4 (.37)	9.4 (.37)	9.4 (.37)	9.4 (.37)	9.4 (.37)	9.4 (.37)
F	35 (1.38)	35 (1.38)	35 (1.38)	50 (1.97)	35 (1.38)	55 (2.17)	65 (2.56)
G	15 (.59)	15 (.59)	15 (.59)	17 (.67)	15 (.59)	25 (.98)	35 (1.38)
GA	15 (.59)	15 (.59)	15 (.59)	42 (1.62)	51 (2.01)	61 (2.40)	111 (4.37)
H	40 (1.58)	40 (1.58)	40 (1.58)	25 (.98)	36 (1.42)	36 (1.42)	38 (1.50)
HA	40 (1.58)	40 (1.58)	40 (1.58)	25 (.98)	36 (1.42)	72 (2.84)	76 (2.99)
J	40.6 (1.60)	40.6 (1.60)	40.6 (1.60)	52.6 (2.07)	72.6 (2.86)	118.6 (4.67)	172.6 (6.80)
K	24.1 (.95)	34.1 (1.34)	44.1 (1.74)	54.1 (2.13)	64.1 (2.52)	89.1 (3.51)	114 (4.49)
M	71 (2.80)	71 (2.80)	71 (2.80)	83 (3.27)	103 (4.06)	149 (5.87)	203 (7.99)
N	4	4	4	4	6	6	6
NN	2	2	2	3	3	4	5
Z	70 (2.76)	70 (2.76)	70 (2.76)	82 (3.23)	102 (4.02)	148 (5.83)	202 (7.95)
ZZ	80 (3.15)	80 (3.15)	80 (3.15)	92 (3.62)	112 (4.41)	158 (6.22)	212 (8.35)



PST12

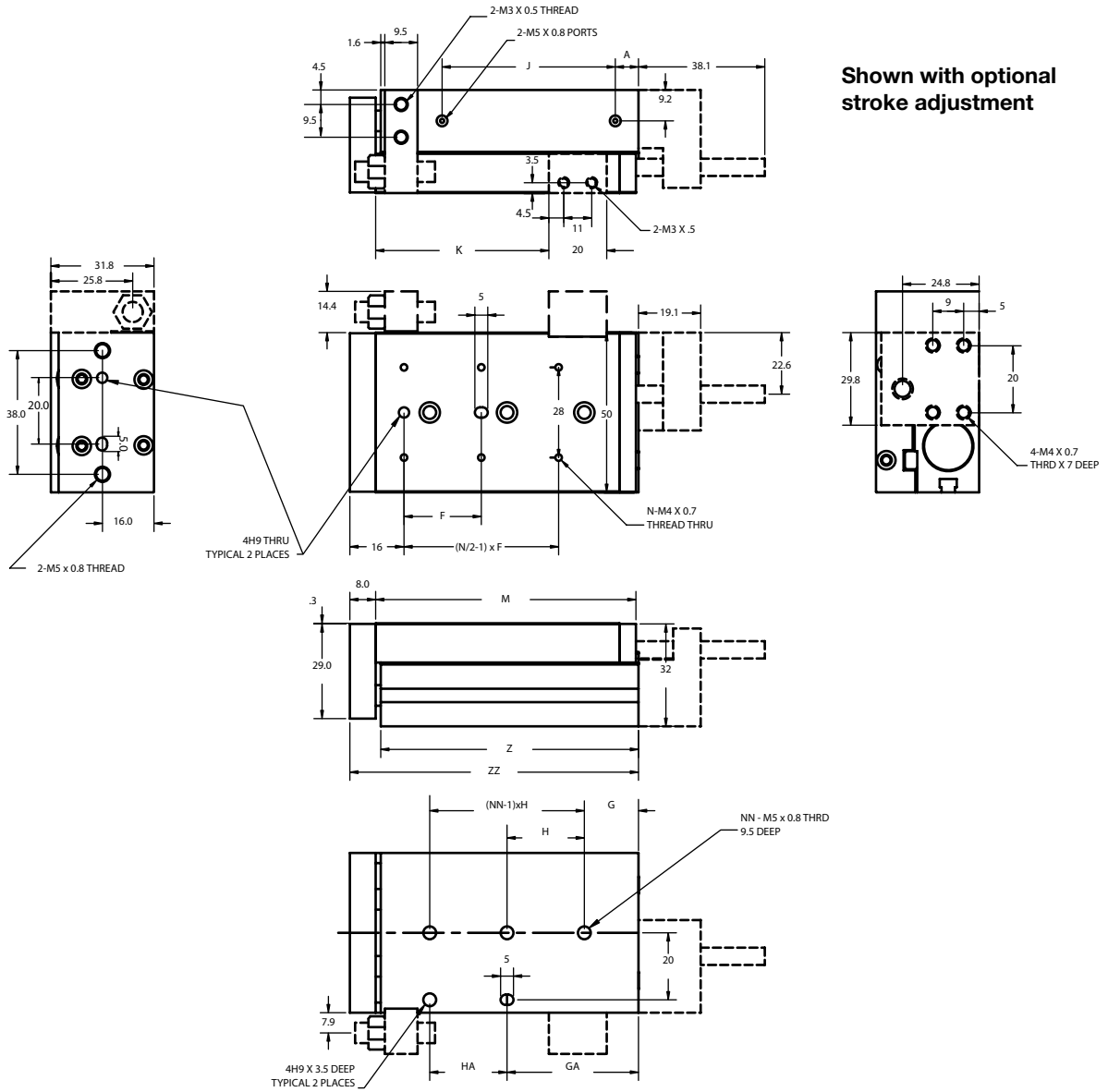

Shown with optional stroke adjustment

Shown With Optional Shock Absorbers

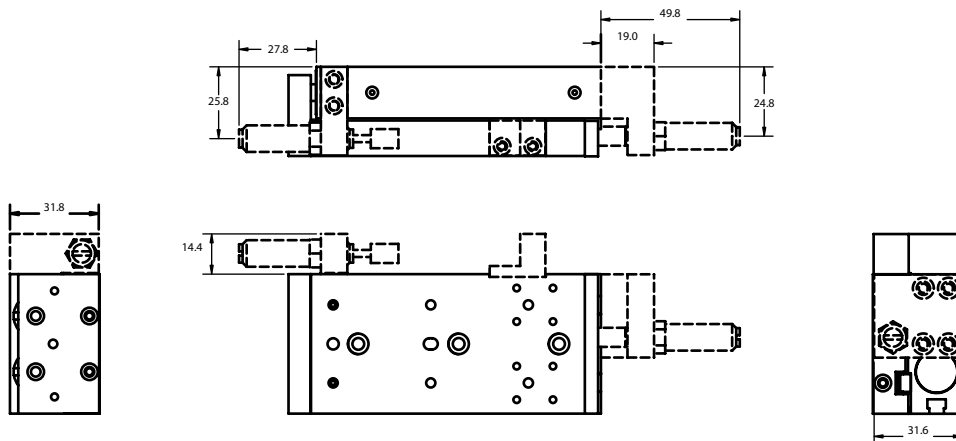



PST Series Precision Slides

NUMATICS®

PST16 Technical Specifications

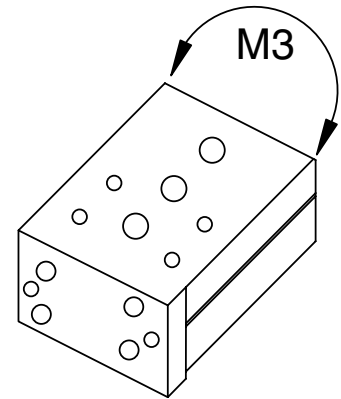
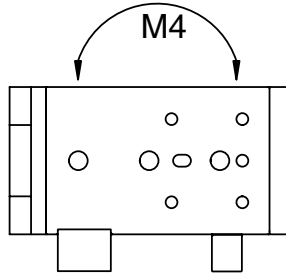
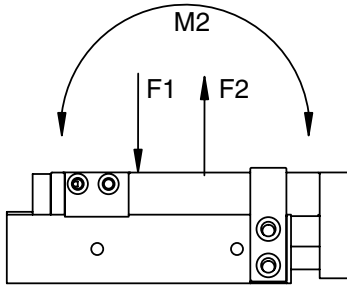

Technical Specifications (Dynamic Ratings)

	PST16
M2 Nm (in.-lbs.)	16.8 (148.4)
M3 Nm (in.-lbs.)	12.7 (112.6)
M4 Nm (in.-lbs.)	20.0 (177.0)
F1: kg (lbs)	22.7 (50.0)
F2: kg (lbs)	15.9 (35.0)

Unit Output Force Table

BORE	EXTEND	RETRACT
16 (piston area inches sq.)	0.624	0.486
16 (piston area mm sq.)	402.0	302.0

Example:

Pounds = Psi x Piston Area inches sq.

Newtons = Mpa x Piston Area mm sq.

PST16 Dimensions

	STROKE MM (INCHES)						
	10	20	30	40	50	75	100
A	7.4 (0.29)	7.4 (0.29)	7.4 (0.29)	7.4 (0.29)	9.0 (0.35)	9.0 (0.35)	9.0 (0.35)
F	35.0 (1.38)	35.0 (1.38)	35.0 (1.38)	40.0 (1.57)	30.0 (1.18)	55.0 (2.16)	65.0 (2.56)
G	16 (0.63)	16.0 (0.63)	16.0 (0.63)	16.0 (0.63)	21.0 (0.83)	26.0 (1.02)	39.0 (1.53)
GA	16.0 (0.63)	16.0 (0.63)	16.0 (0.63)	16.0 (0.63)	51.0 (2.01)	61 (2.40)	109 (4.29)
H	40.0 (1.57)	40.0 (1.57)	40.0 (1.57)	50.0 (1.96)	30.0 (1.18)	35.0 (1.38)	35 (1.38)
HA	40.0 (1.57)	40.0 (1.57)	40.0 (1.57)	50.0 (1.97)	30.0 (1.18)	70.0 (2.76)	70.0 (2.76)
J	44.0 (1.73)	44.0 (1.73)	44.0 (1.73)	54.0 (2.13)	67.0 (2.65)	117.0 (4.62)	165.0 (6.51)
K	27.0 (1.06)	37.0 (1.47)	47.0 (1.86)	57.0 (2.24)	67.0 (2.65)	92.0 (3.63)	117.0 (4.61)
M	76 (2.99)	76 (2.99)	76 (2.99)	86 (3.39)	101.0 (3.98)	151.0 (5.94)	199.0 (7.83)
N	4.0	4.0	4.0	4.0	6.0	6.0	6.0
NN	2.0	2.0	2.0	2.0	3.0	4.0	5.0
Z	75 (2.95)	75.0 (2.95)	75.0 (2.95)	85.0 (3.35)	100.0 (3.94)	150.0 (5.91)	198.0 (7.80)
ZZ	87.0 (3.42)	87.0 (3.42)	87.0 (3.42)	97.0 (3.81)	112.0 (4.41)	162 (6.38)	210.0 (8.26)



PST16

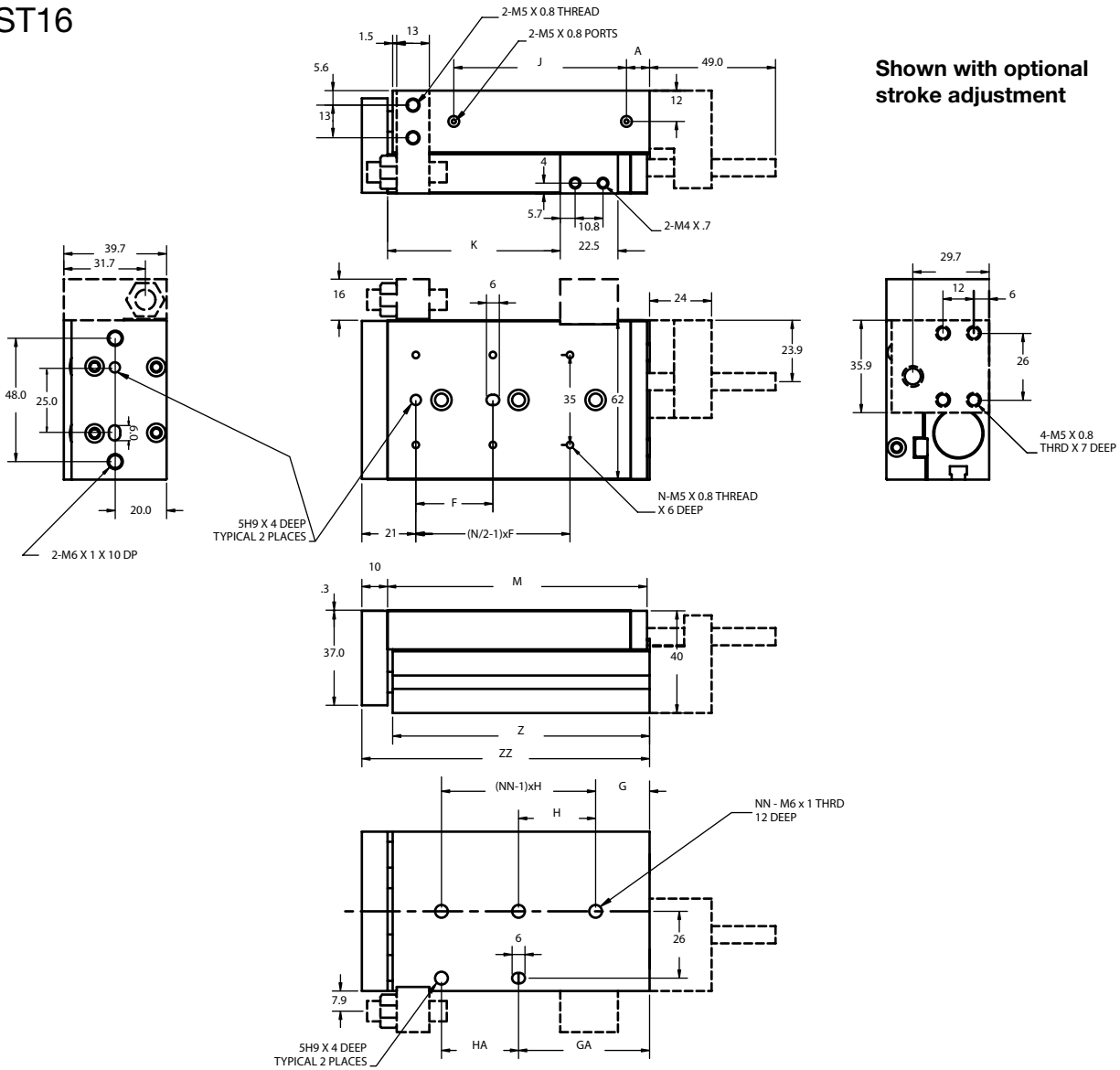

Shown with optional stroke adjustment

Shown With Optional Shock Absorbers

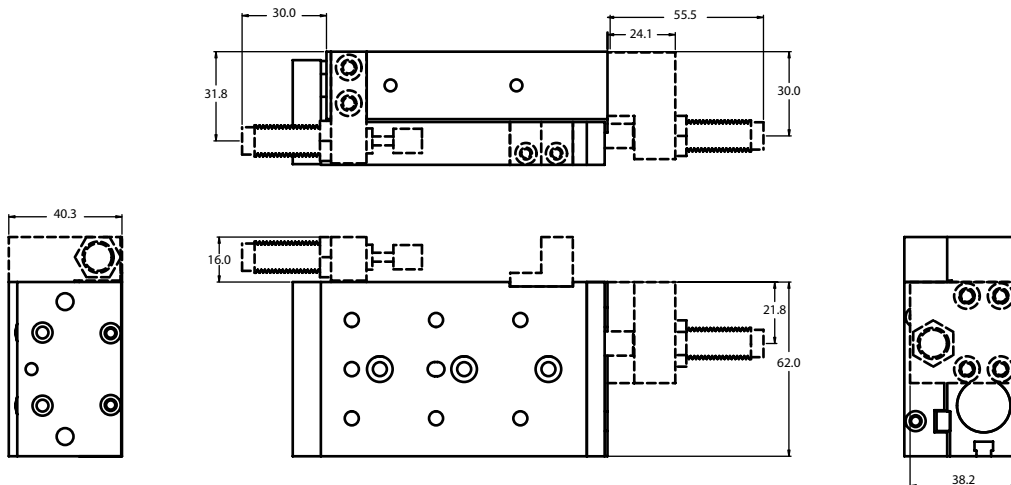



PST Series Precision Slides

NUMATICS®

PST20 Technical Specifications

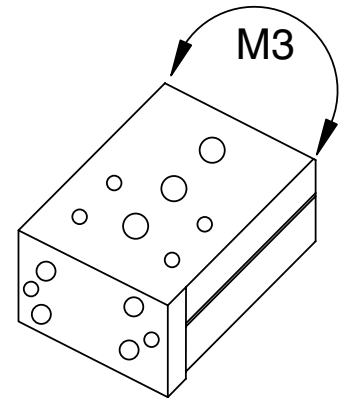
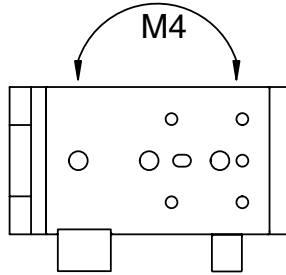
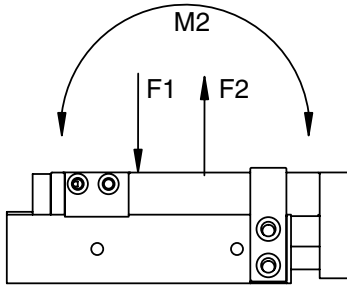

Technical Specifications (Dynamic Ratings)

	PST20
M2 Nm (in.-lbs.)	23.3 (206.6)
M3 Nm (in.-lbs.)	24.6 (217.9)
M4 Nm (in.-lbs.)	27.4 (242.7)
F1: kg (lbs)	29.4 (65.0)
F2: kg (lbs)	20.6 (45.5)

Unit Output Force Table

BORE	EXTEND	RETRACT
20 (piston area inches sq.)	0.973	0.730
20 (piston area mm sq.)	628.0	471.0

Example:

Pounds = Psi x Piston Area inches sq.

Newtons = Mpa x Piston Area mm sq.

PST20 Dimensions

	STROKE MM (INCHES)						
	10	20	30	40	50	75	100
A	10.0 (0.39)	10.0 (0.39)	10.0 (0.39)	10.0 (0.39)	10.5 (0.41)	10.5 (0.41)	10.5 (0.41)
C	40.1 (1.58)	40.1 (1.58)	40.1 (1.58)	50.0 (1.97)	35.0 (1.38)	60.0 (2.36)	70.0 (2.76)
F	50.0 (1.97)	50.0 (1.97)	50.0 (1.97)	60.0 (2.36)	35.0 (1.38)	60.0 (2.36)	70.0 (2.76)
G	15.0 (0.59)	15.0 (0.59)	15.0 (0.59)	15.0 (0.59)	15.0 (0.59)	19.0 (0.75)	37.0 (1.46)
GA	25.0 (0.98)	25.0 (0.98)	25.0 (0.98)	35.0 (1.38)	50.0 (1.97)	54 (2.13)	107 (4.21)
H	45.0 (1.77)	45.0 (1.77)	45.0 (1.77)	55.0 (2.16)	35.0 (1.38)	35.0 (1.38)	35.0 (1.38)
HA	35.0 (1.38)	35.0 (1.38)	35.0 (1.38)	35.0 (1.38)	35.0 (1.38)	70.0 (2.76)	70.0 (2.76)
J	45.6 (1.80)	45.6 (1.80)	45.6 (1.80)	55.0 (2.19)	70.1 (2.76)	109.1 (4.30)	162.1 (6.38)
K	29.3 (1.15)	39.3 (1.55)	49.3 (1.94)	59.3 (2.33)	69.3 (2.73)	94.3 (3.71)	119.3 (4.70)
M	83.0 (3.27)	83.0 (3.27)	83.0 (3.27)	93.0 (3.66)	108.0 (4.25)	147.0 (5.79)	200.0 (7.87)
N	4.0	4.0	4.0	4.0	6.0	6.0	6.0
NN	2.0	2.0	2.0	2.0	3.0	4.0	5.0
Z	81.5 (3.21)	81.5 (3.21)	81.5 (3.21)	91.5 (3.60)	106.5 (4.19)	145.5 (5.73)	198.5 (7.81)
ZZ	97.0 (3.82)	97.0 (3.82)	97.0 (3.82)	107.0 (4.21)	122.0 (4.80)	161.0 (6.34)	214.0 (8.43)



PST20

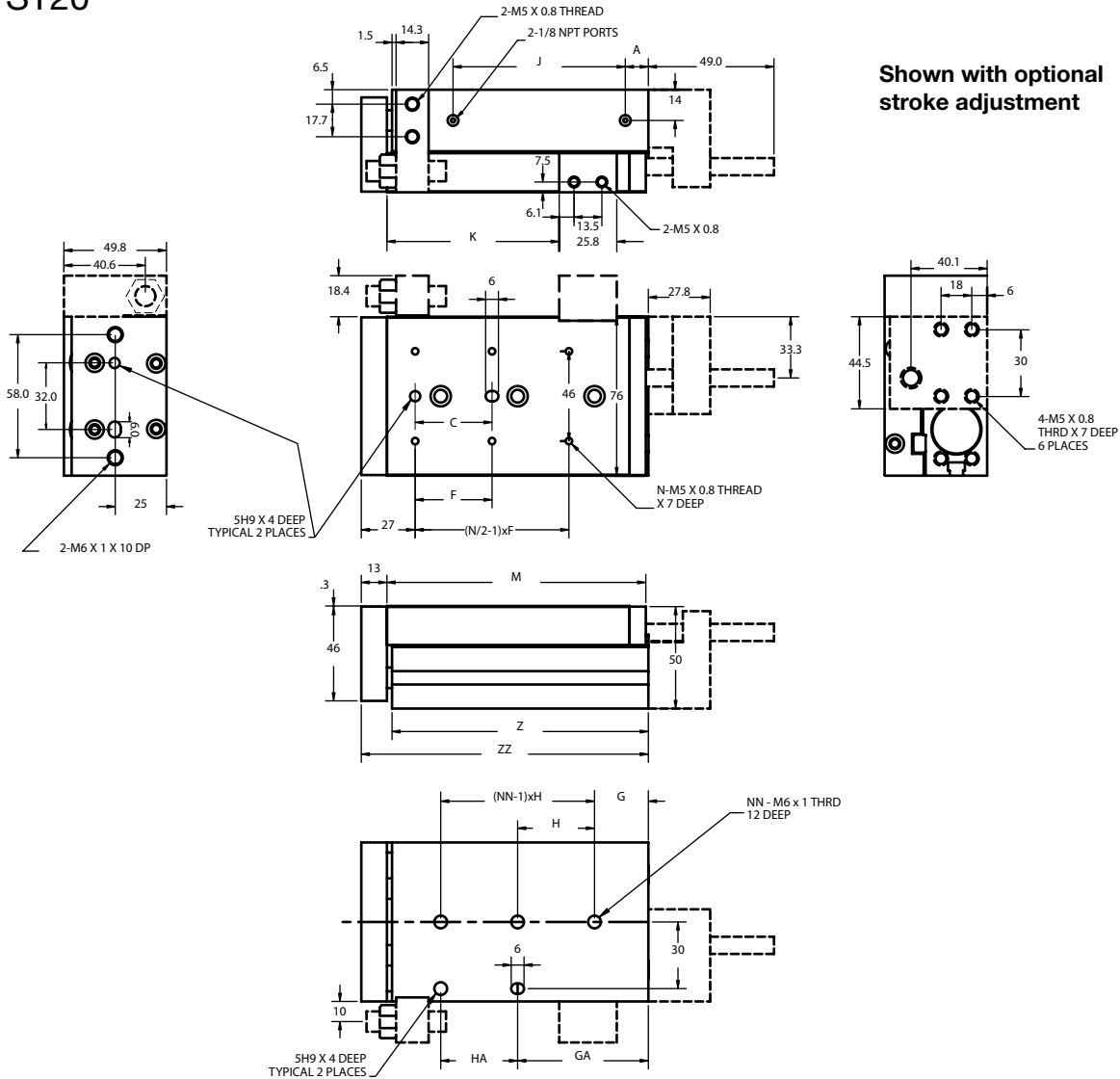

Shown with optional
stroke adjustment

Shown With Optional Shock Absorbers

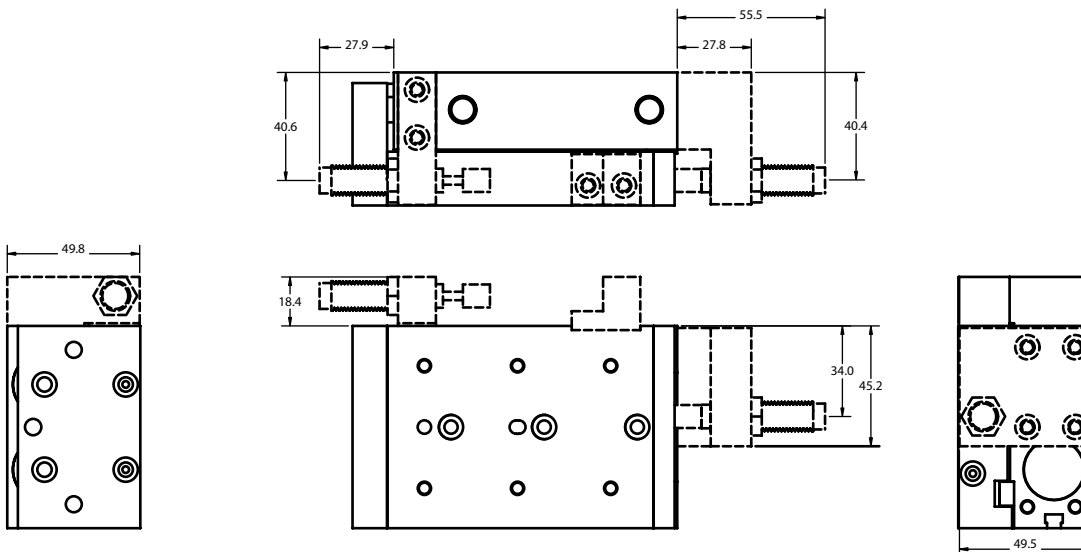



PST Series Precision Slides

NUMATICS®

PST25 Technical Specifications

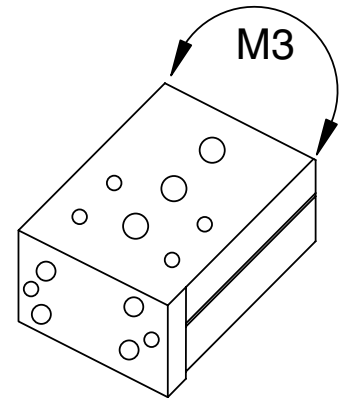
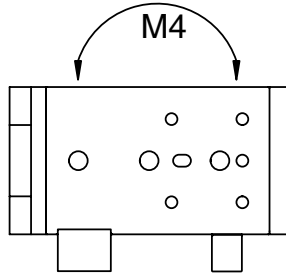
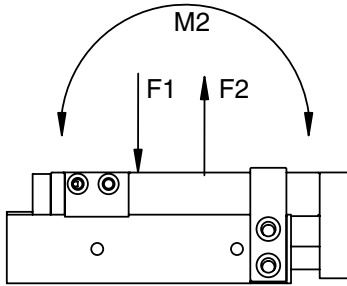

Technical Specifications (Dynamic Ratings)

	PST25
M2 Nm (in.-lbs.)	34.3 (303.3)
M3 Nm (in.-lbs.)	45.1 (399.9)
M4 Nm (in.-lbs.)	41.1 (364.1)
F1: kg (lbs)	40.8 (90.0)
F2: kg (lbs)	28.6 (63.2)

Unit Output Force Table

BORE	EXTEND	RETRACT
25 (piston area inches sq.)	1.522	1.171
25 (piston area mm sq.)	982.0	756.0

Example:

Pounds = Psi x Piston Area inches sq.

Newtons = Mpa x Piston Area mm sq.

PST25 Dimensions

	STROKE MM (INCHES)						
	10	20	30	40	50	75	100
A	8.89 (0.35)	8.89 (0.35)	8.89 (0.35)	8.89 (0.35)	12.09 (0.48)	12.07 (0.48)	12.07 (0.48)
C	40.1 (1.58)	40.1 (1.58)	40.1 (1.58)	50.0 (1.97)	35.0 (1.38)	60.0 (2.36)	70.0 (2.76)
F	50.0 (1.97)	50.0 (1.97)	50.0 (1.97)	60.0 (2.36)	35.0 (1.38)	59.94 (2.36)	70.0 (2.76)
G	22.0 (0.87)	22.0 (0.87)	22.0 (0.87)	22.48 (0.89)	20.02 (0.79)	26.01 (1.02)	32.0 (1.26)
GA	22.0 (0.87)	22.0 (0.87)	22.0 (0.87)	22.0 (0.87)	55.02 (2.17)	60.96 (2.40)	102.01 (4.02)
H	45.0 (1.77)	45.0 (1.77)	45.0 (1.77)	55.0 (2.16)	35.0 (1.38)	35.0 (1.38)	35.0 (1.38)
HA	45.0 (1.77)	45.0 (1.77)	45.0 (1.77)	55.0 (2.16)	35.0 (2.16)	70.0 (2.76)	70.0 (2.76)
J	50.80 (2.00)	50.80 (2.00)	50.80 (2.00)	61.01 (2.40)	70.82 (2.79)	111.84 (4.40)	152.83 (6.02)
K	30.86 (1.22)	40.84 (1.61)	50.80 (2.00)	60.86 (2.40)	70.87 (2.79)	95.86 (3.77)	120.85 (4.76)
M	92.00 (3.62)	92.00 (3.62)	92.00 (3.62)	102.01 (4.02)	115.01 (4.53)	156.01 (6.14)	197.00 (7.76)
N	4.0	4.0	4.0	4.0	6.0	6.0	6.0
NN	2.0	2.0	2.0	2.0	3.0	4.0	5.0
Z	90.50 (3.60)	90.50 (3.60)	90.50 (3.60)	100.97 (3.97)	113.51 (4.47)	154.5 (6.08)	195.50 (7.70)
ZZ	107.99 (4.25)	107.99 (4.25)	107.99 (4.25)	118.5 (4.65)	131.0 (5.16)	172.0 (6.77)	212.99 (8.39)



PST25

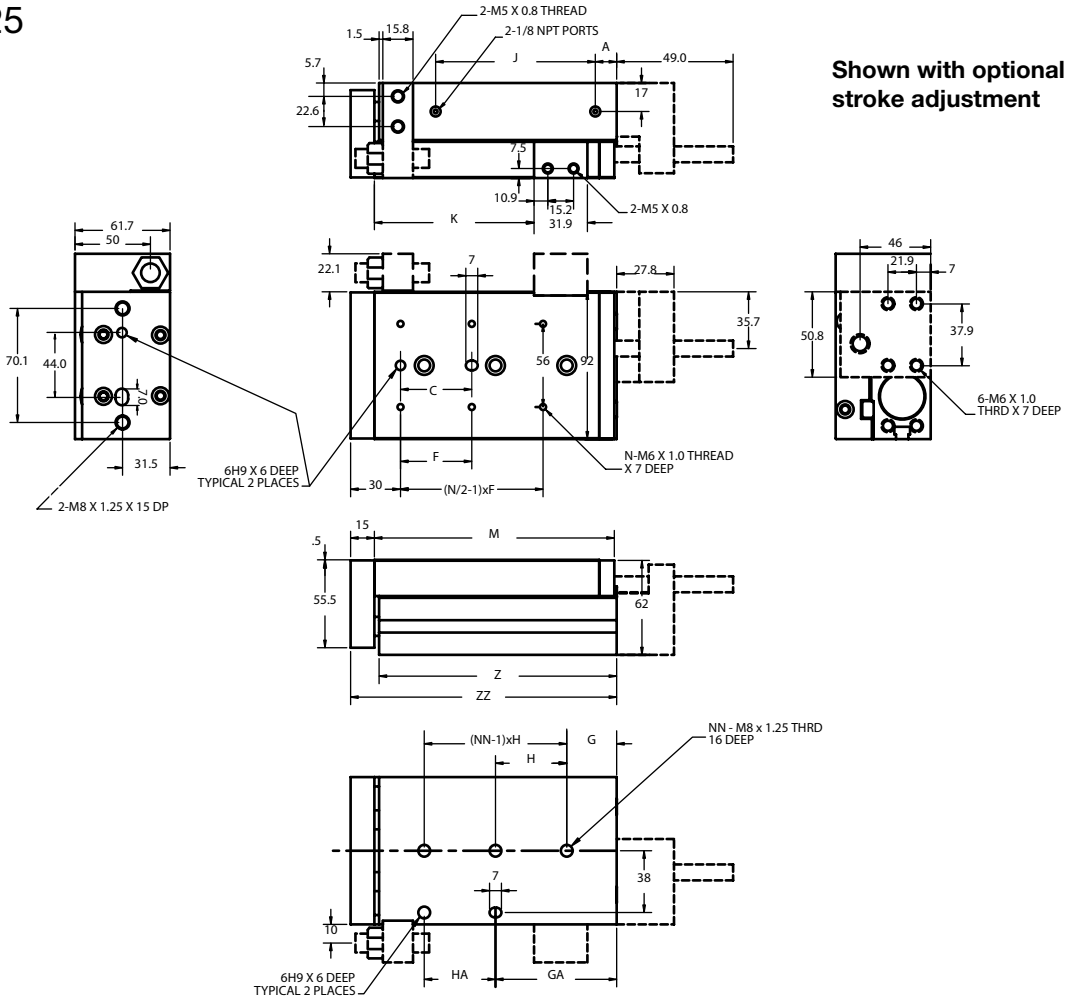

Shown with optional stroke adjustment

Shown With Optional Shock Absorbers

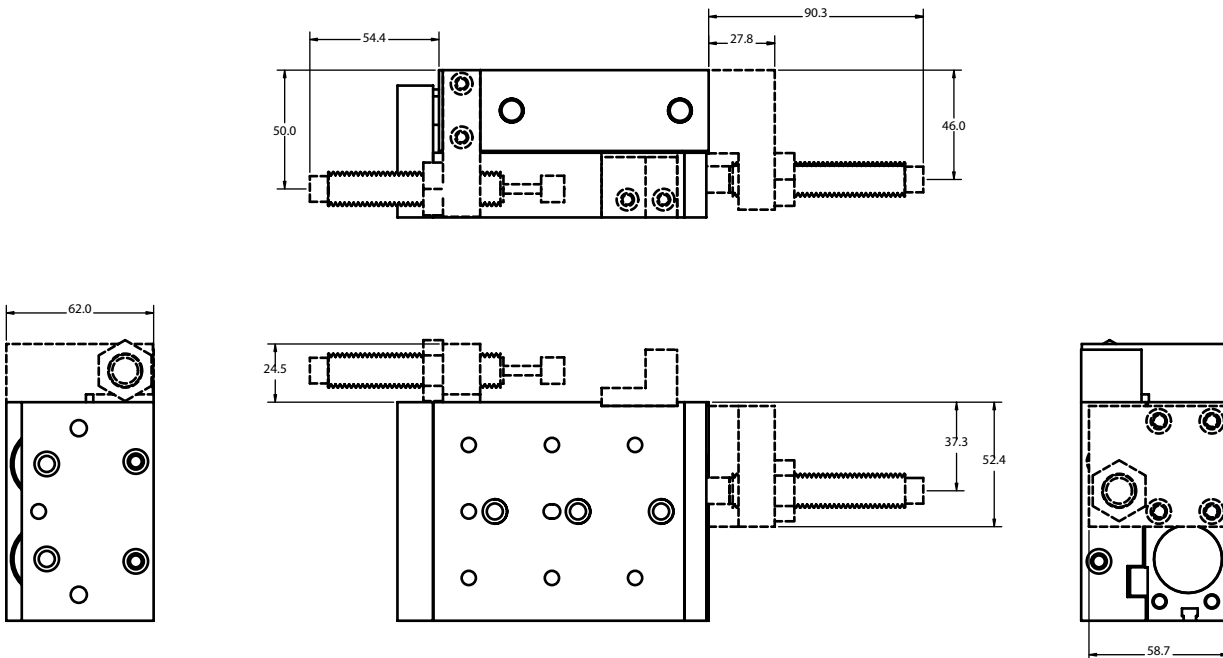



PST Series Precision Slides

NUMATICS®

PST Series Switch Information

	SWITCH OR BRACKET DESCRIPTION	STANDARD PART NO.	QUICK DISCONNECT PART NO.
1	Hall Effect - PNP (Sourcing)	HPNPS31	HPNPQ31
1	Hall Effect -NPN (Sinking)	HNPNS32	HNPNQ32
1	Reed Switch	RSS02	RSQ02

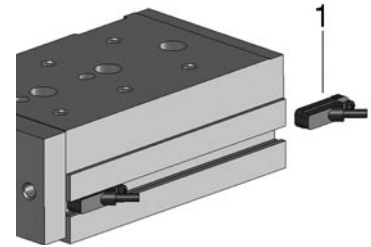

RSS02 – Reed Switch (AC/DC NO), flying lead

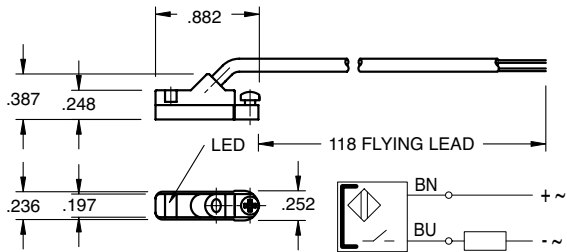

Sensing Data

Ambient temperature range T_a	(°F/°C)	-4 to 176 (-20 to 80)
Frequency of operating cycles f at U_e	(kHz)	0.5
Turn on time t	(ms)	≤ 0.25
turn off time t	(ms)	0.03
LED function indication		yes

Electrical Data

Rated operational voltage U_e	(V)	3...130 AC/DC
Supply voltage U_B	(V)	3...130 AC/DC
Voltage drop U_d at I_e Stat./dyn.	(V)	3.5
Rated insulation voltage U_i	(V)	2750 DC (EN 60335-1)
Rated supply frequency	(Hz)	AC/DC
Rated operational current I_e	(mA)	50 (10W max.)
No-load supply current I_0 at U_e d./und.	(mA)	0
Observe polarity for correct LED function		

RSQ02 – 8mm connector

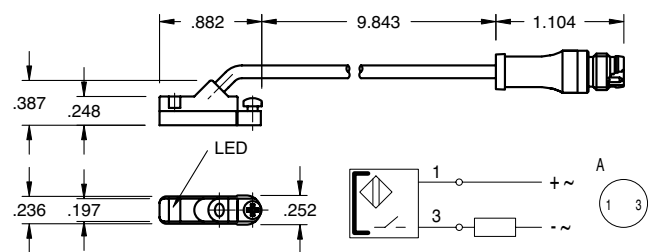

Mechanical Data

Housing material	Polyamide
Material of sensing face	Polyamide
Connection	PVC cable
Degree of Protection	IP 67
Rated shock: half-sinus, 50g, 11 ms	
Rated vibration environment: 10g, 10...2000 Hz, 90 min	



HPNPS31 – Electronic Switch (PNP NO), flying lead

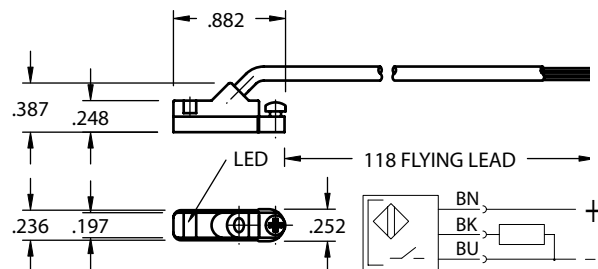

Sensing Data

Ambient temperature range Δ	(°F/°C)	-13 to +158 (-25 to +70)
Temperature drift	(% of)	$\leq 0.3\%/^{\circ}\text{C}$
Frequency of operating cycles f at U_e	(kHz)	10
Turn on time t	(ms)	.05
turn off time t	(ms)	.05
Utilization categories		DC13
Function~/supply voltage indication		YES

Electrical Data

Rated operational voltage U_e	(V)	24 DC
Supply voltage U_B	(V)	10...30 DC
incl. ripple	(% of U_e)	15
Voltage drop U_d at I_e Stat./dyn.	(V)	1/-
Rated insulation voltage U_i	(V)	75 AC
Rated supply frequency	(Hz)	DC
Rated operational current I_e	(mA)	200
No-load supply current I_0 at U_e d./und.	(mA)	25/13
Protected against polarity reversal		YES

HPNPQ31 – 8mm connector

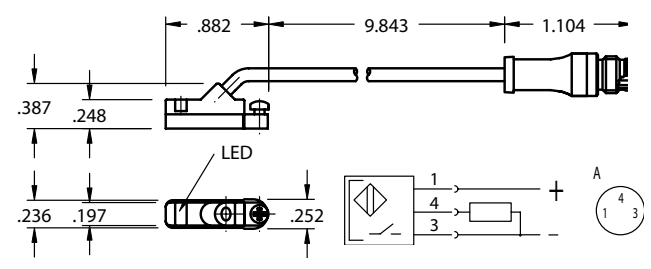

Mechanical Data

Housing material	Polyamide
Material of sensing face	Polyamide
Connection	PVC cable
Degree of Protection	IP 67
Rated shock: half-sinus, 30 g, 11 ms	
Rated vibration environment: 55 Hz, 1mm amplitude, 3 x 30	





HNPNS32 – Electronic Switch (NPN NO), flying lead

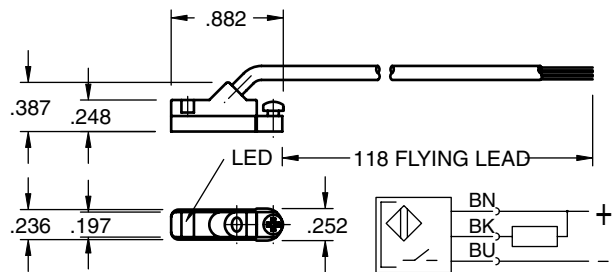

Sensing Data

Ambient temperature range t_d	(°F/°C)	-13 to +158 (-25 to +70)
Temperature drift	(% of S_r)	$\leq 0.3\%/^{\circ}\text{C}$
Frequency of operating cycles f at U_e	(kHz)	10
Turn on time t	(ms)	.05
turn off time t	(ms)	.05
Utilization categories		DC13
Function–supply voltage indication		YES

Electrical Data

Rated operational voltage U_e	(V)	24 DC
Supply voltage U_B	(V)	10...30 DC
incl. ripple	(% of U_e)	15
Voltage drop U_d at I_e Stat./dyn.	(V)	1/-
Rated insulation voltage U_i	(V)	75 AC
Rated supply frequency	(Hz)	DC
Rated operational current I_e	(mA)	200
No-load supply current I_o at U_e d./und.	(mA)	25/13
Protected against polarity reversal		YES

HNPNQ32 – 8mm connector

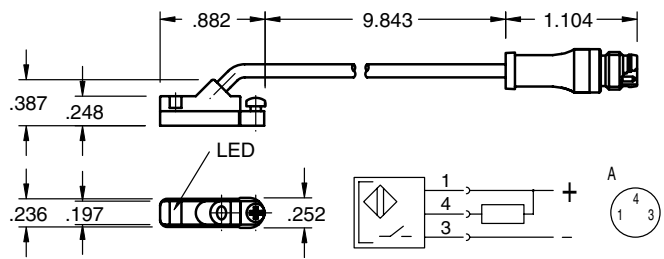

Mechanical Data

Housing material	Polyamide
Material of sensing face	Polyamide
Connection	PVC cable
Degree of Protection	IP 67
Rated shock: half-sinus, 30 g, 11 ms	
Rated vibration environment: 55 Hz, 1mm amplitude, 3 x 30	



Female Connectors for Reed Switches and Hall Effect Sensors

Dimensions (mm)

TYPE	ORDER CODE
Straight, 5 m Cable	PXCST
Elbow, 5 m Calbe	PXC90

Straight Type

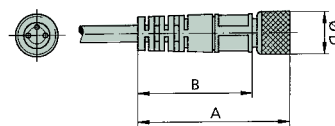

Elbow Type

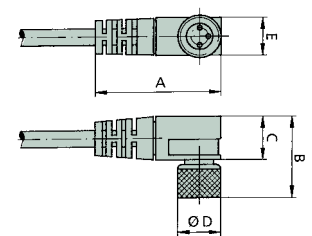

NUMATICS®

World Class Supplier
of Pneumatic Components



World Headquarters

Numatics Incorporated
Phone: 248-887-4111
Fax: 248-887-9190

UNITED STATES

Numatics – Air Preparation
Phone: 810-667-3900
Fax: 810-667-3902

Numatics – Valves

Phone: 248-887-4111
Fax: 248-887-9190

Numatics – Miniature Valves

Phone: 248-960-1400
Fax: 248-960-2160

Numatics – Cylinders

Phone: 615-771-1200
Fax: 615-771-1201

Numatics – Rodless Cylinders

Phone: 519-452-1777
Fax: 519-452-3995

Numatics – Automation

Phone: 440-934-3200
Fax: 440-934-2288

CANADA

Ontario
Numatics, Ltd.
Phone: 519-452-1777
Fax: 519-452-3995

Quebec

Numatics, Ltd.
Phone: 514-332-6444
Fax: 514-332-9273

British Columbia

Numatics, Ltd.
Phone: 604-574-0401
Fax: 604-574-3713

EUROPE

Germany – European Headquarters

Numatics GmbH
Phone: 011-49-22 41-31 60-0
Fax: 011-49-22 41-31 60 40

Hungary

Numatics Kft.
Phone: 011-36-13 82 21 35
Fax: 011-36-12 04 39 47

EUROPE

England
Numatics Limited
Phone: 011-44-1525-37 07 35
Fax: 011-44-1525-38 25 67

France

Numatics s.a.r.l.
Phone: 011-33-1 41 21 48 88
Fax: 011-33-1 41 21 48 89

Italy

Numatics srl
Phone: 011-39-030-373 19 99
Fax: 011-39-030-373 19 81

Netherlands

Numatics B.V.
Phone: 011-31-418-65 29 50
Fax: 011-31-418-65 29 43

Spain

Numatics Spain S.L.
Phone: 011-34-93-221 21 96
Fax: 011-34-93-221 35 14

AFRICA

South Africa
Numatics SA (Pty) Ltd.
Phone: 011-27-11-8 65 44 52
Fax: 011-27-11-8 65 42 90

LATIN & SOUTH AMERICA

Mexico
Numatics de Mexico S.A. de C.V.
Phone: 011-52-222-284 6176
Fax: 011-52-222-284 6179

Brazil

Valvair Comercial Ltda.
Phone: 011-55-12-351 2874
Fax: 011-55-12-351 1958

ASIA & PACIFIC

Australia
Numatics Australia Pty. Ltd.
Phone: 011-61-3-95 63 86 00
Fax: 011-61-3-95 63 85 11

Taiwan – Asian Headquarters

Numatics Co, Ltd. Asia
Phone: 011-886-2-29 15 16 05
Fax: 011-886-2-29 14 18 97

For a comprehensive listing of all Numatics production and distribution facilities worldwide, visit www.numatics.com