

MeltMonitor™ Pressure Indicator and Alarm Series



P/N 974135
12/05 Rev. A
ECO # 30885



QUICK START INSTRUCTIONS

GENERAL MOUNTING INFORMATION

Before mounting the MeltMonitor, check the mounting hole carefully. The MeltMonitor must only be mounted in holes that satisfy the requirements below. A hole that does not satisfy these requirements can damage the pressure sensor.

Insure the mounting hole is clear of any frozen polymer or debris and is machined to the proper dimensions.

Coat the threads with a high temperature anti-seize grease or a suitable parting agent, this will help prevent the MeltMonitor snout from sticking permanently in the mounting hole.

Install unit into the process connection. (Do NOT torque transmitter into the hole at this time!) Allow time for the snout temperature to equalize to the process temperature. This will help eliminate thread galling and ease removal later. There should be NO pressure applied at this time.

Always use a torque wrench applied to the designated hexagon collar while screwing the pressure gauge in and out. Do not apply the tool to the housing or housing/sensor connection.

After temperatures have equalized, apply proper torque as described in Section 3.7 or 5.2 of this manual and tighten the sensor into mounting hole.

After the correct torque has been applied units with flexible capillary require the electronics to be mounted away from the process heat using the mounting hardware.

Make sure that the medium is in molten condition during sensor removal. Removing the sensor while the medium is in solidified condition can damage the sensor diaphragm.

When removing the MeltMonitor, carefully clean the diaphragm of the transmitter with a soft cloth while the medium is still malleable.

BUTTON FUNCTIONS

Set = Enter the current data and move to the next menu item.

Peak = Shift the flashing digit from left to right.

Reset = Edit the flashing digit from 0 - 9.

USER MENU

To enter the **User Menu** push and hold the **SET** button for 5 seconds. Some codes may not be seen depending on what model configuration is supplied.

| Code | Configuration | Settings & Definition |
|------|---|---|
| U11 | Alarm1 Operating Mode (default: 1 = Pressure High) | 1 = PH, Pressure High (high limit pressure alarm) 2 = PL, Pressure Low (low limit pressure alarm) 3 = tH, Temperature High (high limit temperature alarm) 4 = tL, Temperature Low (low limit temperature alarm) 5 = PHr, Pressure High Failsafe (high limit alarm, reverse acting) 6 = PFE, Pressure Low (low limit alarm with masking) 7 = tHr, Temperature High Failsafe (high limit alarm, reverse acting) 8 = tFE, Temperature Low (low limit alarm with masking) 9 = CON (alarm controlled through RS485 communications) |
| U41 | Pressure Units (default: model specific) | 0 = psi 1 = BAR 2 = kgf/cm ² 3 = MPa |









If a change to engineering units is made, the set point also changes but needs to be confirmed by hitting the set button.

| | | |
|-----|--|--|
| U46 | Temperature Units (default: 0) | 0 = °F 1 = °C |
| U51 | Secondary Display Indication (default: 0) | 0 = Off 1 = Temperature Value 2 = Pressure Units (U31) 3 = Alarm1 Set Point Value (U12) 4 = Alarm2 Set Point Value (U22) |

| Code | Configuration | Settings & Definition |
|------|---|--|
| U61 | Retransmission Output Selection (default: 0) | 0 = 4 - 20 mA 1 = 0 - 10 Vdc 2 = 1 - 5 Vdc |

Please refer to Section 6.5 for wiring details.

TABLE OF CONTENTS

| | Content | Page | Icon |
|-----|-------------------------------|------|---|
| 1. | General | 5 |  |
| 2. | Notes on Safety | 8 |  |
| 3. | Technical Data | 9 |  |
| 4. | Transport/Delivery | 17 |  |
| 5. | Installation | 18 |  |
| 6. | Commissioning | 22 |  |
| 7. | Maintenance | 30 |  |
| 8. | Accessories | 32 | |
| 9. | Troubleshooting | 33 |  |
| 10. | Appendix A - MODBus Addresses | 34 | |



1. GENERAL

| | | |
|-----|------------------------------|---|
| 1.1 | Important Information | 5 |
| 1.2 | Copyright | 6 |
| 1.3 | Explanation of Icons | 6 |
| 1.4 | Abbreviations | 6 |
| 1.5 | Principle of Operation | 7 |

1.1 IMPORTANT INFORMATION

This manual applies to the MeltMonitor™ series only. It must be kept near the equipment in a readily and immediately accessible location at all times. The content of this manual must be read, understood and followed in its entirety. This applies in particular to the notes on safety. Following the safety instructions will help to prevent accidents, defects and malfunctions.

Models covered by this manual include the RMM, FMM, RMMT, FMMT, RMMX, FMMX, RMMXT, FMMXT.

The MeltMonitor is a digital design based precision pressure, or pressure & temperature measurement device, which features a dual 5-digit LED display of process variables. With all stainless steel, welded construction, the MeltMonitor has been designed for the rigorous environments of plastics processing machinery. For food or medical processing applications NaK filled and oil-filled versions are available.

With standard features such as digital auto-zero and peak display function, the MeltMonitor offers high accuracy, ease of operation, with simplicity of design. With the optional built-in temperature sensor, the MeltMonitor is capable of displaying both the process pressure and process temperature simultaneously, for real-time operator monitoring of critical process parameters.

MeltMonitor models RMMX and FMMX offer as standard two fully programmable alarm relays, suitable for pressure and/or temperature alarming. The alarms can be programmed for both manual or automatic reset and early warning indication; ideal for optimum process monitoring, alarming, and first alert indication.

In addition the RMMX and FMMX models include 2 digital inputs for remote reset and remote zero, as well as 4-20mA, 0-10Vdc, or 1-5Vdc user-selectable, scalable, process pressure value retransmission. RS485 MODBus communication is also available.

DYNISCO will not be held liable for any injury, loss or damage resulting from failure to follow the instructions in this manual.

If the product malfunctions, in spite of having followed the operating instructions, please contact the **DYNISCO** customer service department (See the back of the manual for contact information). This applies in particular during the warranty period.



1.2 COPYRIGHT

Copyright law requires that this manual be used for intended purposes only.

It is strictly forbidden to allow reproduction of any kind “in whole or in part” to persons outside of Dynisco, without approval from Dynisco.

1.3 EXPLANATION OF ICONS

The manual uses icons to indicate information pertaining to safety:

ATTENTION

Risk of destruction or damage to equipment, machines or installations



General danger to life or limb



Specific danger to life or limb



You **MUST** do this

The safety instructions are provided again in the individual chapters of the manual.

1.4 ABBREVIATIONS

The following abbreviations are used:

| | |
|-------|--|
| OM | Operating Manual |
| RMM | Rigid Melt Monitor |
| FMM | Flexible Melt Monitor |
| RMMT | Rigid Melt Monitor with Thermocouple |
| FMMT | Flexible Melt Monitor with Thermocouple |
| RMMX | Rigid Melt Monitor with Alarms |
| FMMX | Flexible Melt Monitor with Alarms |
| RMMXT | Rigid Melt Monitor with Thermocouple and Alarms |
| FMMXT | Flexible Melt Monitor with Thermocouple and Alarms |
| FS | Full Scale |
| BFSL | Best Fit Straight Line |



1.5 PRINCIPLE OF OPERATION

MeltMonitors are used to make pressure measurements of molten polymers up to 750°F (400°C).

The extreme process temperatures on the diaphragm of the MeltMonitor are isolated from the electronics through a filled capillary tube. The filled capillary tube transmits the process operating pressure to a bonded foil, Wheatstone bridge, strain gauge. The low voltage signal from the strain gauge is digitized through an A/D converter within the MeltMonitor. The digitized signal is processed within the electronics of the MeltMonitor providing a highly accurate measurement and display of the process operating pressure.

Some units come equipped with an integral temperature sensor, which can provide simultaneous digital display of the process temperature. Units which incorporate the integral temperature sensor can be ordered with full process temperature compensation.

Units which include process temperature compensation offer the user highly accurate pressure measurements, with no-zero shift, over the process operating temperature range of 20-325 °C.

2. NOTES ON SAFETY



The operator or owner of the larger overall system is responsible for following the safety and accident prevention regulations that apply to the specific application.

DYNISCO will not be held liable for any injury, loss or damage resulting from failure to follow the instructions in this manual.



Toxic Hazard!

The MeltMonitor may contain a very small amount of mercury (Hg) ~ 0.00429 in³ typically with a 6/30 configuration, as its transmission medium. If the diaphragm is damaged, mercury may escape. Never transport or store the MeltMonitor without the protective cap. Remove the cap shortly before installation.

If mercury is inhaled or swallowed, seek medical attention immediately!

Mercury is hazardous waste and must be disposed of in accordance with applicable laws. **DYNISCO** will accept defective MeltMonitor's. If mercury escapes, use airtight packaging!

Temperature

The MeltMonitor Series of pressure sensors can be used in media temperatures up to 400°C. If the pressure sensor is used in other applications, the safety and accident prevention regulations specific to that application must be followed. Ambient temperature for the case max. +70°C.

Higher temperature can result in damage and malfunction. Do not install the Melt Monitor in places where this temperature is exceeded.



3. TECHNICAL DATA

| | | |
|-------|--|----|
| 3.1 | Ordering Guide for MeltMonitor Series | 10 |
| 3.2 | Ordering Example | 10 |
| 3.3 | Ordering Information | 10 |
| 3.3.1 | MeltMonitor Configuration | 10 |
| 3.3.2 | Display Option | 10 |
| 3.3.3 | Process Connection | 11 |
| 3.3.4 | Pressure Ranges | 11 |
| 3.3.5 | Rigid Stem & Flexible Capillary | 11 |
| 3.4 | Performance Characteristics | 12 |
| 3.4.1 | Accuracy (BFSL) | 12 |
| 3.4.2 | Sampling Speed | 12 |
| 3.4.3 | Power Supply | 12 |
| 3.4.4 | Display | 12 |
| 3.4.5 | Pressure Units | 12 |
| 3.4.6 | Pressure Resolution | 12 |
| 3.4.7 | Temperature Units | 12 |
| 3.4.8 | Temperature Resolution | 13 |
| 3.5 | Temperature & Mechanical Characteristics | 13 |
| 3.5.1 | Electronics Temperature Range | 13 |
| 3.5.2 | Maximum Diaphragm Temperature | 13 |
| 3.5.3 | Humidity | 13 |
| 3.6 | Additional Specifications for MeltMonitor Alarm Series | 13 |
| 3.6.1 | Alarm LEDs | 13 |
| 3.6.2 | Alarms | 13 |
| 3.6.3 | Alarm Range Resolution | 13 |
| 3.6.4 | Digital Inputs | 13 |
| 3.6.5 | Retransmission Outputs | 13 |
| 3.6.6 | Communications | 13 |
| 3.7 | Torque | 14 |
| 3.8 | Weight | 14 |
| 3.9 | Dimensions | 14 |



3.1 ORDERING GUIDE FOR MELTMONITOR SERIES

The exact meanings of the letter/digit combinations are given in the corresponding sections of Chapter 3.

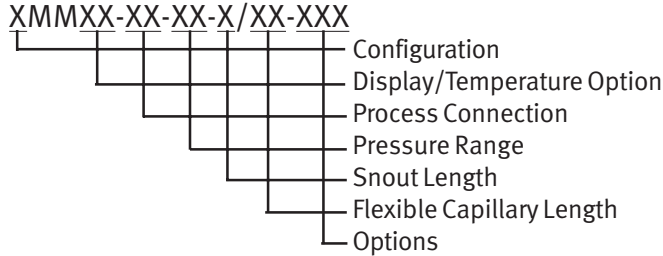

3.2 ORDERING EXAMPLE

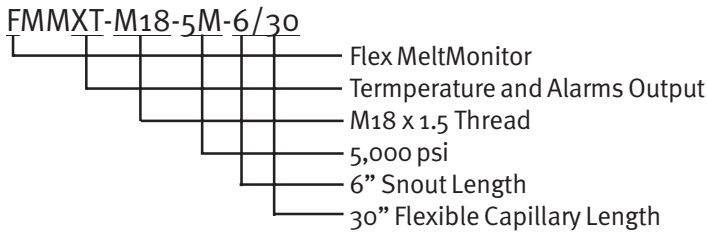

3.3 ORDERING INFORMATION

XMMXX-XX-XX-X/XX-XXX

3.3.1 MELT MONITOR CONFIGURATION

XMMXX-XX-XX-X/XX-XXX

- R = Rigid MeltMonitor
- F = Flexible Melt Monitor

3.3.2 DISPLAY OPTION

XMMXX-XX-XX-X/XX-XXX

- Blank = Pressure Only
- T = Pressure and Temperature
- X = Pressure Only and Alarms
- XT = Pressure, Temperature and Alarms

TECHNICAL DATA



3.3.3 PROCESS CONNECTION

XMMXX-~~XX~~-XX-X/XX-XXX

Blank = 1/2-20 UNF

M18 = M18 x 1.5 THD

3.3.4 PRESSURE RANGE

XMMXX-XX-~~XX~~-X/XX-XXX

5C = 500 psi

1M = 1,000 psi

1.5M = 1,500 psi

3M = 3,000 psi

5M = 5,000 psi*

7.5M = 7,500 psi

10M = 10,000 psi*

15M = 15,000 psi*

20M = 20,000 psi

MeltMonitors are available in other engineering units, such as BAR, MPa and kgf/cm².

* RMM, FMM, RMMT and FMMT are available in these ranges only.

3.3.5 RIGID STEM & FLEXIBLE CAPILLARY

XMMXX-XX-XX-X/~~XX~~-XXX

6 = 6" Rigid Stem/0" Flexible Capillary

6/30 = 6" Rigid Stem/30" Flexible Capillary

12 = 12" Rigid Stem/0" Flexible Capillary

12/30 = 12" Rigid Stem/30" Flexible Capillary

Note: Other lengths are available, please consult the factory.



3.4 PERFORMANCE CHARACTERISTICS

3.4.1 ACCURACY (BFSL)

| | | |
|-------|---|---------------------|
| RMM | = | ±1.0% of full scale |
| FMM | = | ±1.0% of full scale |
| RMMT | = | ±1.0% of full scale |
| FMMT | = | ±1.0% of full scale |
| RMMX | = | ±0.5% of full scale |
| FMMX | = | ±0.5% of full scale |
| RMMXT | = | ±0.5% of full scale |
| FMMXT | = | ±0.5% of full scale |

Note: More accurate versions of the MeltMonitor are available, please consult the factory.

All temperature measurements have an accuracy of ±0.5%.

3.4.2 SAMPLING SPEED

50 mS

3.4.3 POWER SUPPLY

Universal 110/220 Vac or 24 Vdc

3.4.4 DISPLAY

5-digit LED's, 0.5" Primary and 0.4" Secondary

3.4.5 PRESSURE UNITS

PSI, bar, MPa and kgf/cm²

3.4.6 PRESSURE RESOLUTION

1 PSI, 0.1 bar, 0.01 MPa and 0.1 kgf/cm²

3.4.7 TEMPERATURE UNITS

°F and °C



3.4.8 TEMPERATURE RESOLUTION

0.1°F and 0.1°C

3.5 TEMPERATURE & MECHANICAL CHARACTERISTICS

3.5.1 ELECTRONICS TEMPERATURE RANGE

32 - 158°F (0 to 70°C)

3.5.2 MAXIMUM DIAPHRAGM TEMPERATURE

750°F (400°C), If NaK or Oil Fill is used, max diaphragm temperature changes.

3.5.3 HUMIDITY

Less than or equal to 80% RH

3.6 ADDITIONAL SPECIFICATIONS FOR THE MELTMONITOR ALARM SERIES

3.6.1 ALARM LED'S

Alarm 1, Alarm 2, IN (Reset), A/B (MODBus)

3.6.2 ALARMS

(2) -1-SPDT + 1-SPST Relay, 110 - 200 Vac - Dry Relay

3.6.3 ALARM RANGE RESOLUTION

00001 - FS Value

3.6.4 DIGITAL INPUTS

Remote Zero & Remote Reset

3.6.5 RETRANSMISSION OUTPUTS

4 - 20 mA, 0 - 10 Vdc, 1 - 5 Vdc

3.6.6 COMMUNICATIONS

RS-485 MODBus - RTU



3.7 TORQUE

max. 56.5 Nm
(500 inch-lbs.)

min. 11.3 Nm
(100 inch-lbs.)

3.8 WEIGHT

The weight varies depending on product configuration. Average weight range is 2 to 4 pounds.

3.9 DIMENSIONS

See Figures 3-1 through 3-4.



Fig. 3-1 MeltMonitor Indicator Series

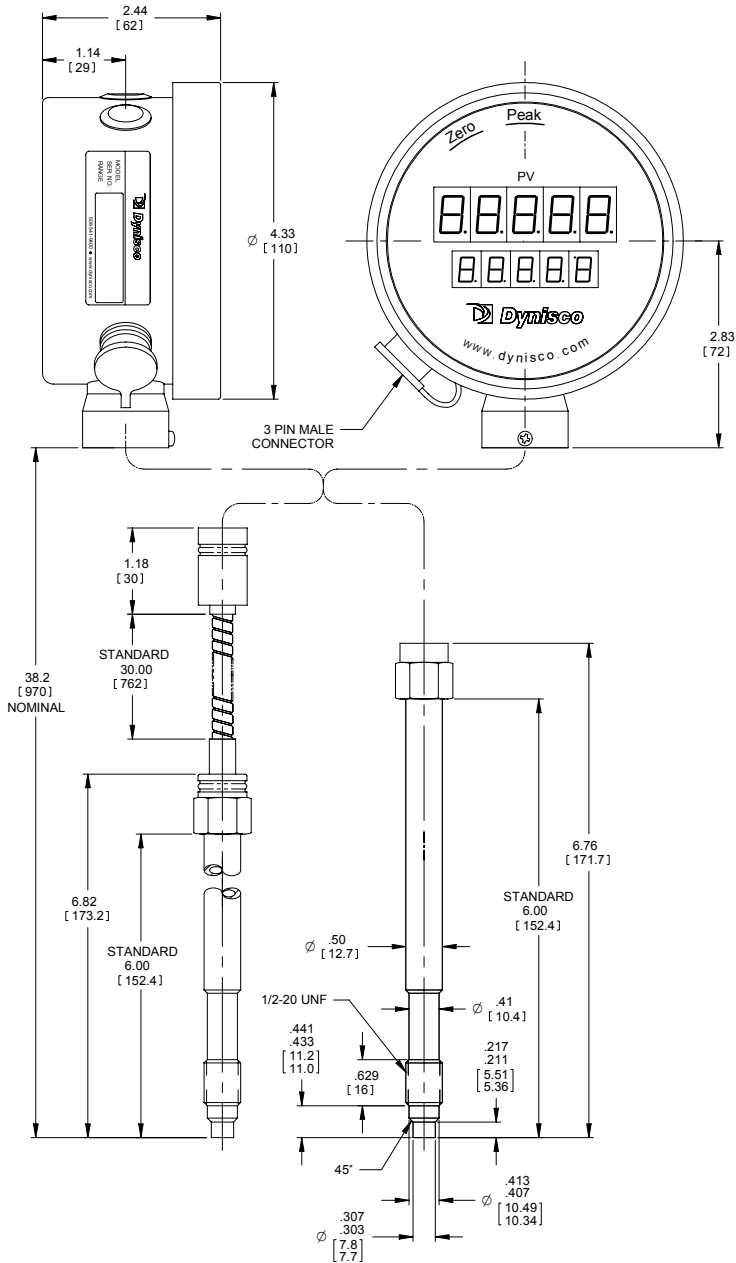

TECHNICAL DATA



Fig. 3-2 MeltMonitor Alarm Series

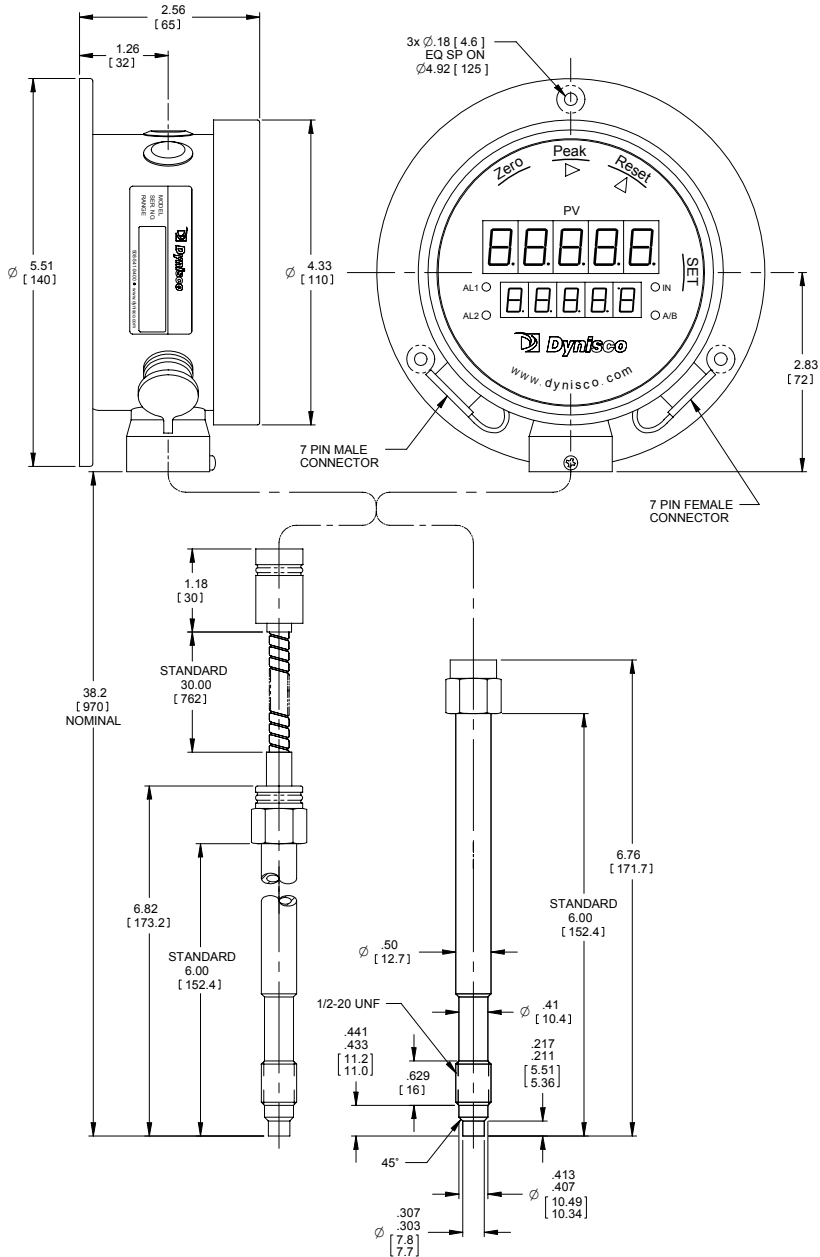

TECHNICAL DATA



4. TRANSPORT/DELIVERY

| | | |
|-----|--|----|
| 4.1 | Transport/Packing/Transport Damage | 17 |
| 4.2 | Storage | 17 |
| 4.3 | Scope of Delivery | 17 |



Toxic hazard!

The MeltMonitors contain a small amount of mercury (Hg) as its transmission medium. If the diaphragm is damaged, mercury may escape.



Never transport or store the MeltMonitor without the protective shell bolted in place. Remove the shell shortly before installation.

If mercury is inhaled or swallowed, seek medical attention immediately.

Mercury is hazardous waste and must be disposed of in accordance with applicable laws. **DYNISCO** will accept defective MeltMonitors.

If mercury escapes, use airtight packaging!

4.1 TRANSPORT/PACKING/TRANSPORT DAMAGE

- Do not let the MeltMonitor be damaged by other items during transit.
- Use only the original packaging.
- Report transport damage to **DYNISCO** immediately in writing.

4.2 STORAGE

- Store the MeltMonitor in original packaging only.
- Protect against dust and moisture.

4.3 SCOPE OF DELIVERY

- MeltMonitor with diaphragm protection cap
- Mounting Flange (MeltMonitor with flexible stem only)
- Operating manual



5. INSTALLATION

| | | |
|-----|------------------------------------|----|
| 5.1 | General Mounting Information | 18 |
| 5.2 | Mounting Hole Torque | 19 |
| 5.3 | Mounting Hole Dimensions | 19 |
| 5.4 | Mounting the MeltMonitor | 21 |

5.1 GENERAL MOUNTING INFORMATION

Do not remove the protective cap on the MeltMonitor until ready to install.

Before mounting the MeltMonitor, check mounting hole carefully. The MeltMonitor must only be mounted in holes that satisfy the requirements below. A hole that does not satisfy these requirements can damage the pressure sensor.

Insure the mounting hole is clear of any frozen polymer or debris and is machined to the proper dimensions.

Coat the threads with a high temperature anti-seize grease or a suitable parting agent, this will help prevent the MeltMonitor snout from sticking permanently in the mounting hole.

Install unit into the process connection. (Do NOT torque transmitter into the hole at this time!) Allow time for the snout temperature to equalize to the process temperature. This will help eliminate thread galling and ease removal later. There should be NO pressure applied at this time.

Always use a torque wrench applied to the designated hexagon collar while screwing the pressure gauge in and out. Do not apply the tool to the housing or housing/sensor connection.

After temperatures have equalized, apply proper torque as described in Section 3.7 or 5.2 of this manual and tighten the sensor into mounting hole.

After the correct torque has been applied units with flexible capillary require the electronics to be mounted away from the process heat using the mounting hardware.

Make sure that the medium is in molten condition during sensor removal. Removing the sensor while the medium is in solidified condition can damage the sensor diaphragm.

When removing the MeltMonitor, carefully clean the diaphragm of the transmitter with a soft cloth while the medium is still malleable.



Always remove the MeltMonitor prior to cleaning the machine with abrasives or steel wire brushes. Also, do not clean the MeltMonitor with hard objects, such as a screwdriver, a wire brush, etc. this will possibly damage the transmitter.

Before reinstalling the MeltMonitor, ensure that the mounting hole is free from hardened plastic. A mounting hole cleaning tool kit is available to aid in removing of the material. (Dynisco Part Number 200100.) A gauge plug to check the hole is included in this kit.



The most common causes of sensor damage are: installation in improperly machined or plugged mounting holes and cold starts. The tip of the MeltMonitor consists of a stainless steel diaphragm that must be protected from severe abrasives, dents and scores.



Burn Hazard! The MeltMonitor must be removed with the melt in the molten condition. The MeltMonitor can be very hot when removed. **WEAR PROTECTIVE GLOVES!**

Careful attention should be paid to correctly machine the mounting port. Failure to use the recommended mounting port may result in erroneous pressure measurement, difficult sensor removal, premature sensor failure, process fluid leaks, and personnel injury. In applications involving high temperature operation and/or repeated thermal cycling a good high quality anti-seize compound should be applied to the threaded surfaces.

5.2 MOUNTING HOLE TORQUE

max. 56.5 Nm
(500 inch-lbs.)
min. 11.3 Nm
(100 inch-lbs.)

5.3 MOUNTING HOLE DIMENSIONS



Fig. 5-1 1/2-20 UNF Mounting Hole

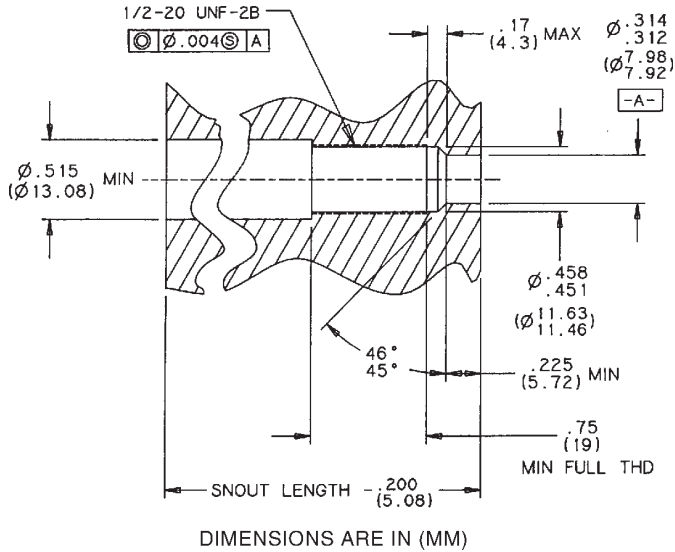
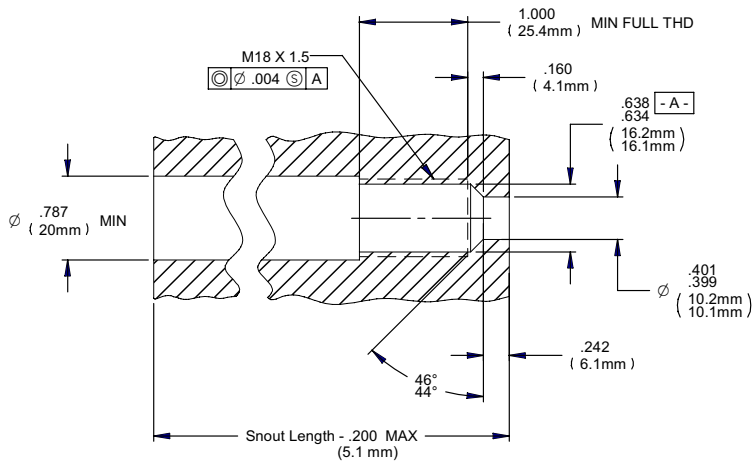

Fig. 5-2 M18 x 1.5 THD Mounting Hole





5.4 MOUNTING THE MELT MONITOR

Dynisco offers a set of mounting hole-machining tools with all the necessary drills, taps, and reamers for the Dynisco standard $\frac{1}{2}$ -20UNF-2A mounting holes used in high temperature and plastics processing applications (Dynisco Part Number 200925). Detailed instructions are sent with the machining kits. Copies of the instructions are available from Dynisco upon request.

When machining the hole pay careful attention to the concentricity between the threads and the 0.312/0.314 diameter. Since the pressure seal is on the 45° seating surface, this surface should be examined for good finish, free from burrs, etc.

It is general good practice to check the mounting hole before installing the MeltMonitor. One procedure is to coat a gauge plug (Dynisco Part Number 200908 for the $\frac{1}{2}$ -20 standard port), with Dykem blue on surfaces below the thread. Insert the gauge plug into the mounting hole and rotate until surface binding is encountered. Remove and inspect. Bluing should only be scraped off of the 45° sealing chamfer. If bluing has been removed from other surfaces, the mounting hole has not been machined properly.



6. COMMISSIONING

- 6.1 XMM Front Panel Display 22
- 6.2 XMMX Front Panel Display 22
- 6.3 Zeroing the MeltMonitor 23
- 6.4 Electrical Connection for the XMM 23
- 6.5 Electrical Connection for the XMMX 24
- 6.6 RMMX & FMMX Menu and Instructions 25
- 6.6.1 Button Functions 25
- 6.6.2 User Menu 25
- 6.6.3 Operator Menu 28

6.1 XMM FRONT PANEL DISPLAY

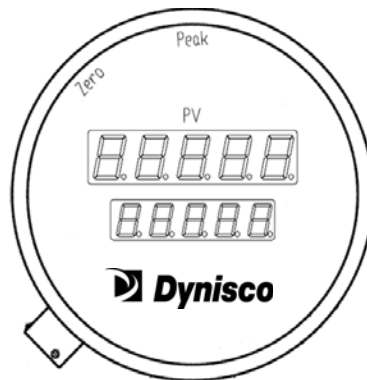

Zero = Sets the pressure value to zero or resets the peak values while flashing.

Peak = Flashes the pressure and temperature peak values.

Connector = 3 Pin Silver male connector (left side) for power, see wiring details in Section 6.4.

6.2 XMMX FRONT PANEL DISPLAY

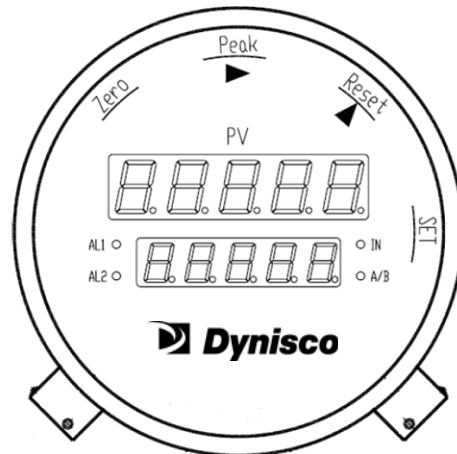



Zero = Sets the pressure value to zero or resets the peak values while flashing.

Peak = Flashes the pressure and temperature peak values.

Reset = Manually resets the alarms.

Set = Enters and exits menus.

LEDs

AL1 = Indication of Alarm 1 (flashing in early warning stage).

AL2 = Indication of Alarm 2 (flashing in early warning stage).

IN = Indication of remote reset input

A/B = Indication of MODBUS communications

Connector = 3 Pin Silver male connector for power, see wiring details in Section 6.5

Connector = 7 Pin Black female connector for power, see wiring details in Section 6.6

6.3 ZEROING THE MELTMONITOR

Insure the mounting hole is clear of any frozen polymer or debris and is machined to the proper dimensions. Apply a quality high temperature Anti-Seize lubricant to the snout tip threads. Install unit into the process connection. (Do NOT torque transmitter into the hole at this time!) Allow time for the transmitter snout temperature to equalize to the process temperature. This will help eliminate thread galling and ease removal later. There should be NO pressure applied at this time.

Connect power to the transmitter, see section 6.4 or 6.5 depending on the model. Insure proper supply voltage is applied to the MeltMonitor.

After temperatures have equalized, apply proper torque as described in Section 5.2 of the Manual and tighten transmitter into mounting hole.

Zero the melt monitor with the Auto-Zero push-button located on the top left hand side of the unit. Allow sufficient soak time to assure that any material at the MeltMonitor diaphragm is molten before the extruder drive is engaged.

6.4 ELECTRICAL CONNECTION FOR THE XMM

For the Melt Monitor with the Universal Power Supply the pin outs are as follows:

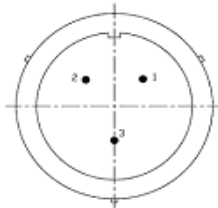



| | | |
|-------|-----------------|-------|
| Pin 1 | Vac (100 – 240) | Black |
| Pin 2 | LN | White |
| Pin 3 | Ground | Green |

For the Melt Monitor with the 24 Vdc Power Supply the pin outs are as follows:

| | | |
|-------|---------|-------|
| Pin 1 | +24 Vdc | Black |
| Pin 2 | o Vdc | White |
| Pin 3 | Ground | Green |

6.5 ELECTRICAL CONNECTION FOR THE XMMX

For the Melt Monitor with the Universal Power Supply the pin outs are as follows:

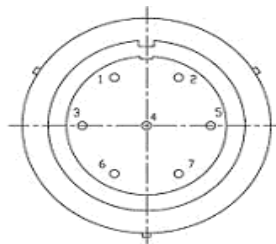
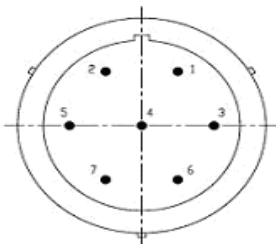

7 pin Male (Silver)

| | | |
|-------|-----------------|--------|
| Pin 1 | Vac (100 – 240) | Black |
| Pin 2 | LN | White |
| Pin 3 | Ground | Green |
| Pin 4 | Relay 1 NC | Brown |
| Pin 5 | Relay 1 NO | Red |
| Pin 6 | Relay Com | Blue |
| Pin 7 | Relay 2 NO | Yellow |

7 pin Female (Black)

| | |
|-------|-------------|
| Pin 1 | Vout (R500) |
| Pin 2 | mA + |
| Pin 3 | o V |
| Pin 4 | ZeroSW |
| Pin 5 | RstSW |
| Pin 6 | RS-485 - A |
| Pin 7 | RS-485 - B |

For the Melt Monitor with the 24 Vdc Power Supply the pin outs are as follows:

7 pin Male (Silver)

| | | |
|-------|------------|--------|
| Pin 1 | +24 Vdc | Black |
| Pin 2 | o Vdc | White |
| Pin 3 | Ground | Green |
| Pin 4 | Relay 1 NC | Brown |
| Pin 5 | Relay 1 NO | Red |
| Pin 6 | Relay Com | Blue |
| Pin 7 | Relay 2 NO | Yellow |

7 pin Female (Black)

| | |
|-------|-------------|
| Pin 1 | Vout (R500) |
| Pin 2 | mA + |
| Pin 3 | o V |
| Pin 4 | ZeroSW |
| Pin 5 | RstSW |
| Pin 6 | RS-485 - A |
| Pin 7 | RS-485 - B |

For both the universal and the 24 Vdc powered Melt Monitor, Pin 3 on the 7 pin Female (Black) is common for pins 1, 2, 4 and 5. Vout works only when pins 1 and 2 are connected.



6.6 RMMX & FMMX MENU & INSTRUCTIONS

6.6.1 BUTTON FUNCTIONS

Set = Enter the current data and move to the next menu item.

Peak = Shift the flashing digit from left to right.

Reset = Edit the flashing digit from 0 - 9.

6.6.2 USER MENU

To enter the **User Menu** push and hold the **SET** button for 5 seconds. Some codes may not be seen depending on what model configuration is supplied.

| Code | Configuration | Settings & Definition |
|-------------------------------|---|---|
| U02 (default: No Password) | Password | This code will only appear if preset in the User Menu U92. |
| U11 | Alarm1 Operating Mode (default: 1 = Pressure High) | 1 = PH, Pressure High (high limit pressure alarm) 2 = PL, Pressure Low (low limit pressure alarm) 3 = tH, Temperature High (high limit temperature alarm) 4 = tL, Temperature Low (low limit temperature alarm) 5 = PHr, Pressure High Failsafe (high limit alarm, reverse acting) 6 = PFE, Pressure Low (low limit alarm with masking) 7 = tHr, Temperature High Failsafe (high limit alarm, reverse acting) 8 = tFE, Temperature Low (low limit alarm with masking) 9 = CON (alarm controlled through RS485 communications) |
| U13 | Alarm1 Hysteresis (default: 25 psi for pressure) (default: 2.5 for temperature) | Adjustable from 0 - 999 |
| U14 | Alarm1 Reset Mode (default: 0) | 0 = Manual Reset, Latching Alarm (Reset only with Reset button or remote input) 1 = Auto Reset |
| U15 | Alarm1 Early Warning Offset from Set-point (default: 0) | Adjustable from 0 - 999 |

AL1 LED begins to flash when the process value enters the early warning range. For high alarms the range is from minus offset value to set point. For low alarms the range is set from set point to plus offset value.

**Code****Configuration****Settings & Definition**

U21

Alarm2 Operating Mode
(default: 0)

0 = Alarm2 Off
 1 = PH, Pressure High (high limit pressure alarm)
 2 = PL, Pressure Low (low limit pressure alarm)
 3 = tH, Temperature High (high limit temperature alarm)
 4 = tL, Temperature Low (low limit temperature alarm)
 5 = PHr, Pressure High Failsafe (high limit alarm, reverse acting)
 6 = PFE, Pressure Low (low limit alarm with masking)
 7 = tHr, Temperature High Failsafe (high limit alarm, reverse acting)
 8 = tFE, Temperature Low (low limit alarm with masking)
 9 = CON (alarm controlled through RS485 communications)

U23

Alarm2 Hysteresis
(default: 25)

Adjustable from 0 - 999

U24

Alarm2 Reset Mode
(default: 0)

0 = Manual Reset, Latching Alarm (Reset only with **Reset** button or remote input)
 1 = Auto Reset

U25

Alarm2 Early Warning
Offset from Set-point
(default: 0)

Adjustable from 0 - 999

AL2 LED begins to flash when the process value enters the early warning range. For high alarms the range is from minus offset value to set point. For low alarms the range is set from set point to plus offset value.

U41

Pressure Units
(default: model specific)

0 = psi
 1 = BAR
 2 = kgf/cm²
 3 = MPa

If a change to engineering units is made, the set point also changes but needs to be confirmed by hitting the set button.

U42

Pressure Display
Offset Value
(default: 0)

Adjustable from -99 to +99 (only affects MM display)

U43

Full Scale Pressure
Display
(Read only)

Displays the FS pressure value from the MM



| Code | Configuration | Settings & Definition |
|------|---|--------------------------|
| U44 | Zero Button and Remote Zero Limit Adjustment (default: 400) | Adjustable from 0 - 3000 |

Allows the user to limit the maximum adjustment value of the **Zero** button and the remote zero feature plus/minus. For BAR or kgf/cm² ranges the value is with one decimal place. For MPa ranges the value is with two decimal places.

| | | |
|-----|--|---|
| U45 | Factory Setting Control (default: 0) | 0 = off 1 = on (enables and jumps to U99 for factory settings) |
| U46 | Temperature Units (default: 0) | 0 = °F 1 = °C |
| U47 | Temperature Offset Adjustment (default: 0) | Adjustable from -30.0 to +30.0 |
| U48 | Process Temperature Set by User (default: 0) | Adjustable from 15 - 400°C |

This configuration enables the user to input a process temperature value for use in the temperature compensation mode, in the event that the internal temperature sensor fails. The user should input a value in the MeltMonitor is to be used in the temperature compensated mode at U82.

| | | |
|-----|--|--|
| U51 | Secondary Display Indication (default: 0) | 0 = Off 1 = Temperature Value 2 = Pressure Units (U41) 3 = Alarm1 Set Point Value (U12) 4 = Alarm2 Set Point Value (U22) |
| U61 | Retransmission Output Selection (default: 0) | 0 = 4 - 20 mA 1 = 0 - 10 Vdc 2 = 1 - 5 Vdc |

Please refer to Section 6.5 for wiring details.

| | | |
|-----|---|--------------------------------|
| U62 | Retransmission End Trim (default: 100%) | Adjustable from 20% to 110% FS |
|-----|---|--------------------------------|



| Code | Configuration | Settings & Definition |
|-------------|--|--|
| U63 | Retransmission Start Trim (default: 0%) | Adjustable from -10% to 50% FS |
| U64 | Retransmission Control (default: 0) | 0 = by Process Value 1 = CON controlled through RS485 communications |
| U71 | MODBUS Slave Address (default: 1) | Adjustable from 1 - 99 |
| U72 | MODBUS Baud Rate (default: 3) | 0 = 1,200 bps 1 = 2,400 bps 2 = 4,800 bps 3 = 9,600 bps 4 = 19,200 bps 5 = 38,400 bps |
| U73 | MODBUS Parity Check (default: 0) | 0 = None 1 = Odd 2 = Even |
| U82 | Temperature Compensation Selection (default: 0) | 0 = No Temperature Compensation 1 = Temperature Compensation (Factory Settings) |
| U91 | Operator Menu Password (default: 0) | Adjustable from 0 - 99 |
| U92 | User Menu Password (default: 0) | Adjustable from 0 to 00 |
| U94 | Software Version (Read Only) | Indicates the SW version of the MeltMonitor |
| U95 | MeltMonitor Serial Number (Read Only) | Indicates the Serial Number of the MeltMonitor |
| U96 | MeltMonitor Error Codes (Read Only) | Indicates MeltMonitor Error Codes |
| U99 | Restore Factory Defaults (U45 must be on) | Input 1234 will restore factory settings. |



6.6.3 OPERATOR MENU

To enter the **Operator Menu**, Press the **Set** button.

| Code | Configuration | Settings & Definition |
|-------------|---|---|
| U01 | Password (default: No Password) | This code will only appear if preset in the User Menu U91. |
| U12 | Alarm1 Set Point Value (default: FS) | Adjustable from 1 - FS. |
| U22 | Alarm2 Set Point Value (default: FS) | Adjustable from 1 - FS. Alarm2 setpoint only appears if activated in the user menu at U21 |



7. MAINTENANCE

| | | |
|-----|-----------------------|----|
| 7.1 | Maintenance | 30 |
| 7.2 | Repair/Disposal | 30 |
| 7.3 | Warranty | 31 |

7.1 MAINTENANCE



Burn hazard!

The MeltMonitor must be removed with the melt in molten condition. The MeltMonitor can be very hot when removed.



Wear protective gloves!

Installation and Removal Instructions

- DO NOT REMOVE PROTECTIVE CAP UNTIL READY TO INSTALL.
- PRIOR TO INITIAL INSTALLATION, VERIFY CORRECT MACHINING OF MOUNTING HOLE.
- WHEN REINSTALLING, MAKE SURE MOUNTING HOLE IS CLEAR OF DEBRIS OR HARDENED PLASTIC.
- THE MEDIUM MUST BE IN MOLTEN CONDITION DURING TRANSDUCER REMOVAL. (Removing the transducer with the medium in a solidified condition can damage the sensor diaphragm.)
- ALWAYS REMOVE THE MeltMonitor BEFORE CLEANING THE MACHINE WITH ABRASIVES OR STEEL WIRE BRUSHES, ETC.
- DO NOT CLEAN THE “SCREWED-IN” SECTION OF THE MeltMonitor WITH HARD OBJECTS – THIS WILL DAMAGE THE MeltMonitor.
- ALWAYS USE A TORQUE WRENCH APPLIED TO THE DESIGNATED HEXAGONAL COLLAR WHEN SCREWING THE MeltMonitor IN AND OUT. DO NOT APPLY THE TOOL TO THE HOUSING OR HOUSING/ SENSOR CONNECTION.

7.2 REPAIR/DISPOSAL

Toxic hazard!

The MeltMonitor may contain a small amount of mercury (Hg) as its transmission medium. If the diaphragm is damaged, mercury may escape.

Never transport or store the MeltMonitor without the protective cap bolted in place. Remove the cap shortly before installation.

If mercury is inhaled or swallowed, seek medical attention immediately!



Mercury is hazardous waste and must be disposed of in accordance with applicable laws. **DYNISCO** will accept defective MeltMonitors.

If mercury escapes, use airtight packaging!

Please send defective pressure gauges back to your **DYNISCO** representative. For **DYNISCO** addresses, see the back cover of the operating manual.

7.3 **WARRANTY**

The MeltMonitor Series of Dynisco Pressure gauges will provide excellent service and superior performance if proper care is taken during handling, installation, and use. This DYNISCO product is warranted under terms and conditions set forth in the DYNISCO web pages. Go to www.dynisco.com and click “warranty” at the bottom of any page for complete details.

8. ACCESSORIES

- Machining tool kit 1/2"-20UNF-2A P/N 200295
- Cleaning tool kit 1/2"-20UNF-2A P/N 200100



9. TROUBLESHOOTING

Symptom

Corrective Actions

Large Zero Shift when Screwing In

- 1) Check Hole with Gage Plug and Rework Hole as Required
- 2) Check Mounting Torque

No Response to Changes in Applied Pressure

- 1) Check Port/Pipe for Blockage or Solidified Plastic

Pressure Variable Reading is Low or High

- 1) Check zero with no pressure applied.
- 2) Check Port/Pipe for Blockage or Solidified Plastic

Pressure Variable Reading is Erratic

- 1) Check Port/Pipe for Blockage or Solidified Plastic

10. APPENDIX

MODBUS settings and Read/Write Register Address

1. Factory option G119

G119: Enable or disable

2. Modbus user control:

U71: Slave number

U72: Baudrate

U73: Parity check

3. Read/Write address and content (Hex format)

0x0200: U12 set point of Alarm1

0x0201: U22 set point of Alarm2

0x0202: U32 set point of Alarm3

0x0203: On/Off status of Alarm1 (relates to U11=Con 9)

0x0204: On/Off status of Alarm2 (relates to U21=Con 9)

0x0205: On/Off status of Alarm3 (relates to U31=Con 9)

0x0206: Retransmission value (0x0000—0x3fff or 16383) (relates to U64=By C)

4. Read only address and content (Hex format)

0x0207: U43 Full range

0x0208: U41 Pressure unit

0x0209: PV of current pressure

0x020A: Peak pressure

0x020B: U46 temperature unit

0x020C: PV of current temperature

0x020D: Peak temperature

0x020E: Software version of meltmonitor

0x020F: Error code

0x0210: Meltmonitor serial number

DyniscoLLC
38 Forge Parkway
Franklin, MA 02038
USA

Tel: +1 508 541 9400
Fax: +1 508 541 9436
Email: Infolnst@dynisco.com

Dynisco Europe GmbH
Wannenäckerstraße 24
74078 Heilbronn
Deutschland

Tel: +49 7131 2970
Fax: +49 7131 23260
Email: DyniscoEurope@dynisco.com

Dynisco Instruments S.a.r.l.
466, rue du Marché Rollay
94500 Champigny sur Marne
France

Tel: +33 1 4881 8459
Fax: +33 1 4881 8334
Email: DyniscoFrance@dynisco.com

Dynisco.s.r.l.
Via Adriatico, 2/2
20162 Milano
Italia

Tel: +39 02 661 01733
Fax: +39 02 661 02908
Email: Dyniscoltaly@dynisco.com

Dynisco UK Ltd.
Silver Birches Business Park
Aston Road, Bromsgrove
Worcestershire B60 3EU
Great Britain

Tel: +44 1527 577077
Fax: +44 1527 577070
Email: DyniscoUK@dynisco.com

Dynisco SPOL, S.R.O.
cp. 579
756 55 Dolni Becva
Czech Republic

Tel: +42 0571 647228
Fax: +42 0571 647224
Email: Dynisco_cz@ova.pvtnet.cz

Dynisco B.V.
Weidehek 53A
4824 At Breda
The Netherlands

Tel: +31 (0) 76 549 0530
Fax: +31 (0) 76 549 0540
Email: Dynisco-BV@dynisco.com



Dynisco
Service

**24 HOURS A DAY
7 DAYS A WEEK**

www.dynisco.com

1-800-DYNISCO (US)
00-800-DYNISCO-0 (Europe)